



©2012 Mettler-Toledo, LLC

No part of this manual may be reproduced or transmitted in any form or by any means, electronic or mechanical, including photocopying and recording, for any purpose without the express written permission of Mettler-Toledo, LLC.

U.S. Government Restricted Rights: This documentation is furnished with Restricted Rights.

---

## Publication Revision History

Part Number	Date	Revisions
<b>64070241 R00</b>	12/2010	Official release
<b>64070241 R01</b>	3/2011	Minor formatting updates.
<b>64070241 R02</b>	4/2011	Changes pg 2-11 Overrides, & 3-19 DST value.
<b>64070241 R03</b>	4/2012	Change to LLC. Updated Memory and added Batch Queue to Chapter 2. Major updates to Chapter 3 to add features up through 1.1.9, Self Service Mode instructions, Label Editor, and COOL, etc. Updated Label Installation Chapter 4 and Cleaning in Chapter 5.
<b>64070241 R04</b>	7/2012	Updates to Chapter 3 GS1Barcode setup and WEP configuration 3-55.
<b>64070241 R05</b>	8/2012	Updated Nutrifacts setup per version 1.1.13, updated NF Labels Vertical Simplified examples, added missing section on PLU Access Parameters, and Wireless Configuration in Chapter 3.
<b>64070241 R06</b>	6/2013	Add FCC Notice Section.
<b>64070241 R07</b>	8/2013	Updates to Wifi section for MTWA5
<b>64070241 R08</b>	8/2014	Updates for Impact M 1.4.4
<b>64070241 R09</b>	2/2015	Updates for Impact M 1.5.10

---

## Trademarks

METTLER TOLEDO® and Impact M® are registered trademarks of Mettler-Toledo, LLC, Columbus, OH, USA.

---

## FCC Notice

This device complies with Part 15 of the FCC Rules and the Radio Interference Requirements of the Canadian Department of Communications. Operation is subject to the following conditions: (1) this device may not cause harmful interference, and (2) this device must accept any interference received, including interference that may cause undesired operation.

This equipment has been tested and found to comply with the limits for a Class A digital device, pursuant to Part 15 of FCC Rules. These limits are designed to provide reasonable protection against harmful interference when the equipment is operated in a commercial environment. This equipment generates, uses, and can radiate radio frequency energy and, if not installed and used in accordance with the instruction

manual, may cause harmful interference to radio communications. Operation of this equipment in a residential area is likely to cause harmful interference in which case the user will be required to correct the interference at their own expense.

## Precautions

READ this manual BEFORE operating or servicing this equipment.

FOLLOW these instructions carefully.

SAVE this manual for future reference.



DO NOT allow untrained personnel to operate, clean, inspect, maintain, service, or tamper with this equipment.

ALWAYS DISCONNECT this equipment from the power source before cleaning or performing maintenance.

CALL METTLER TOLEDO® for parts, information, and service.

METTLER TOLEDO® reserves the right to make refinements or changes without notice.

	<b>NOTICE</b>
	<b>TO PREVENT EQUIPMENT DAMAGE</b> Read and understand the operators manual before using the equipment. Failure to follow operating instructions could result in equipment damage.

	 <b>WARNING</b>
	<b>ELECTRICAL SHOCK HAZARD</b> Only permit qualified personnel to service this equipment. Exercise care when making checks, tests and adjustments that must be made with power on.

	 <b>WARNING</b>
	<b>ELECTRICAL SHOCK HAZARD</b> Connect to a properly grounded outlet only. Do not remove the ground prong. Power outlets must be easily accessible and located no further than the length of the power cord supplied with the product.

	 <b>WARNING</b>
	<b>ELECTRICAL SHOCK HAZARD</b> Disconnect and lock out all power to this unit before removing or installing the fuse, cleaning, or servicing.

	<b>NOTICE</b>
	<b>ELECTROSTATIC SENSITIVE DEVICES</b> Observe precautions for handling electrostatic sensitive devices.

	<b>NOTICE</b>
	<b>EQUIPMENT DAMAGE</b> Disconnect power before connecting or disconnecting any internal electronic components or interconnecting wiring between electronic equipment.

# CONTENTS

<b>1</b>	<b>Introduction .....</b>	<b>1-1</b>
	<b>General .....</b>	<b>1-1</b>
	<b>Specifications .....</b>	<b>1-2</b>
	<b>Power.....</b>	<b>1-3</b>
	<b>Network Connection.....</b>	<b>1-3</b>
	<b>Leveling the Scale.....</b>	<b>1-4</b>
<b>2</b>	<b>Operating Instructions .....</b>	<b>2-1</b>
	<b>Main Screen .....</b>	<b>2-1</b>
	<b>Operator Screen .....</b>	<b>2-2</b>
	Operator Setup .....	2-2
	Beeper .....	2-2
	Language.....	2-2
	Set Time .....	2-2
	Set Date.....	2-3
	System Status.....	2-3
	Set Home Screen .....	2-3
	Restart.....	2-3
	Calibration Audit Trail.....	2-3
	Label Printer .....	2-4
	Voids.....	2-5
	Presets .....	2-5
	Create Preset.....	2-5
	Create Page .....	2-7
	Swap Presets .....	2-8
	Delete Preset .....	2-9
	Quick Edit.....	2-9
	Recent PLUs .....	2-10
	Select Department .....	2-10
	Display Settings .....	2-11
	Remote Assistance .....	2-11
	Operator Logon.....	2-11
	Transaction Mode Logon .....	2-12
	<b>Customer Display.....</b>	<b>2-13</b>
	<b>PLU Pricing Modes .....</b>	<b>2-13</b>
	By-Weight PLU.....	2-13
	By-Count PLU .....	2-14
	Standard Pack PLU.....	2-14
	PLU Screen Details .....	2-15
	<b>Calling PLUs.....</b>	<b>2-16</b>
	<b>Printing Labels.....</b>	<b>2-17</b>
	By Weight PLU.....	2-17
	By Count PLU .....	2-18
	Standard Pack PLU.....	2-18
	<b>Temporary Overrides .....</b>	<b>2-19</b>
	<b>Memory Mode.....</b>	<b>2-20</b>
	<b>Batch Queue .....</b>	<b>2-21</b>
	<b>Self Service Mode .....</b>	<b>2-22</b>

<b>COOL</b> .....	<b>2-23</b>
-------------------	-------------

**3 Admin Functions ..... 3-1**

**Admin Button ..... 3-1**

**Item Database..... 3-2**

Item Database Editor.....	3-2
REM Master Editor.....	3-3
PLUs.....	3-3
Extra Text.....	3-7
Nutrifacts.....	3-7
COOL.....	3-9
Create/Edit COOL Text.....	3-10
Tracking or Lot Numbers.....	3-12
COOL Records and Lists.....	3-13
COOL Setup.....	3-19
Label Formats.....	3-20
Using COOL.....	3-21
Accumulators.....	3-22
Reports.....	3-23
Clear.....	3-23
Action Code.....	3-24
Grade.....	3-25
Group.....	3-26
Department Settings.....	3-27
Edit.....	3-27
Clear.....	3-28

**Presets..... 3-29**

Delete.....	3-29
Swap Pages.....	3-29
Edit Name.....	3-30
Change Grid.....	3-30
Programming Presets.....	3-30

**Labels ..... 3-33**

Label Styles.....	3-33
Print Test Label.....	3-34
Verify Labels.....	3-34

**Unit Setup..... 3-35**

Time & Date.....	3-36
Scale Settings.....	3-37
Scale Mode.....	3-38
Operator Permissions.....	3-38
Supervisor Permissions.....	3-39
Transaction Settings.....	3-39
PLU Access Parameters.....	3-43
Barcode Settings.....	3-45
GS1 Bar Code Setup.....	3-47
COOL.....	3-51
Store Logo.....	3-51
Database.....	3-52
Screen Saver.....	3-54
Preset Settings.....	3-55
Nutrition Settings.....	3-56
2011 Nutrition Facts Formats.....	3-57
Safe Handling Graphics.....	3-58
Set Home Screen.....	3-58

Language.....	3-59
Technician.....	3-59
Communication .....	3-59
Network Comm.....	3-60
STEM Comm.....	3-63
WiFi Com.....	3-64
Touch Screen Calibration.....	3-67
Backup/Restore.....	3-68
<b>Printer Setup.....</b>	<b>3-70</b>
Label parameters .....	3-71
<b>Security.....</b>	<b>3-72</b>
Users and passwords .....	3-73
<b>System Status.....</b>	<b>3-74</b>
System Information.....	3-74
Log View.....	3-75
Log Level .....	3-75
<b>Quick Edits.....</b>	<b>3-76</b>
<b>Select Department.....</b>	<b>3-77</b>
<b>Marquee.....</b>	<b>3-78</b>
Setup.....	3-78
Import Image.....	3-80
<b>Self Service Mode Setup.....</b>	<b>3-81</b>
<b>Label Editor.....</b>	<b>3-86</b>
Label Format Graphics.....	3-89
Extended Label .....	3-90
<b>Tare Preset Configuration .....</b>	<b>3-92</b>
<b>4 Labels.....</b>	<b>4-1</b>
<b>Loading Labels.....</b>	<b>4-1</b>
<b>Label Requirements.....</b>	<b>4-2</b>
Label Paper.....	4-2
Activation Temperature.....	4-2
Adhesive.....	4-2
Release Liner.....	4-3
Total Thickness (LABEL + ADHESIVE + LINER).....	4-3
Light transmission for Gap Sensor Operation .....	4-3
Label Stripping.....	4-3
Finished Label Roll Requirements .....	4-3
Core and Method of Label Attachment.....	4-3
Die Cutting .....	4-4
Slitting .....	4-4
Winding.....	4-4
Label; Curl .....	4-4
Splicing .....	4-4
Finished Label and Roll Dimensional Requirements .....	4-5
<b>Preprinted Labels.....</b>	<b>4-7</b>
<b>Special Shaped Labels.....</b>	<b>4-8</b>
<b>Optical Densities.....</b>	<b>4-9</b>
Definition of Transmission of Optical Density .....	4-9
Label and Liner Optical Density.....	4-9
Black Stripe Optical Density .....	4-9
<b>5 Maintenance.....</b>	<b>5-1</b>

**External Cleaning.....5-1**  
**Printer Cleaning.....5-2**

**6 Appendix..... 6-1**  
**Geo Index.....6-1**  
**Country Currency Defaults .....6-3**  
**Country Time Defaults .....6-4**  
**Misc. Country Defaults.....6-5**



# 1 Introduction

## General

Thank you for purchasing an Impact M<sup>®</sup> scale. The METTLER TOLEDO<sup>®</sup> Impact series was designed for your current and future requirements and it can handle a variety of operations and adapt to changing process and data requirements. This flexibility protects your investment and helps you keep pace with rapidly changing production and customer demands.





The Impact M scale offers very easy programming with a user friendly interface. All scales contain a built-in thermal label printer which is designed for quick and easy roll changes. Also, the Impact M provides a large, full-color LCD display for easy PLU look-up and straightforward operator control.

The Impact M is a low-profile counter scale with an easy-to-navigate user interface. The Impact M can be operated in a standalone mode with a local database or connected to a REM or STEM through an Ethernet network using TCP/IP protocol. In client mode, the Impact M can be on the same network as the Model UC-ST, 8361, 8450, or 8461 scales.

## Specifications

Description	Specifications – Impact M
Capacity x Division	30 x 0.01 lb 15 x 0.005 kg 6/15 x 0.002/0.005 kg 15/30 x 0.005/0.01 lb
Weighing Modes	lb , kg, (single and dual interval)
Dimensions	H: 5.875", W: 15.35", D: 17.5"
Platter Dimension	W: 15.25" x D: 9.25" (10.0" counting lip)
Weight of Unit	23.5 lb (10.7 kg)
Shipping Weight	30.0 lb (13.7 kg)
Base Construction	Cast metal upper shell with sheet metal bottom
Operator Display	10.4" color VGA touchscreen
Operator Keyboard / Touchscreen	4 wire resistive Touchscreen
Customer Display	Monochrome 320 x 240 LCD
Printer	3" nominal (72 mm paper, 80mm path), up to 5"/sec, thermal - 6" roll capacity
Label Sizes	Default label sizes include 1.9", 2.1", 2.4", 3.3", 4.2", 4.7", 5.1", and Continuous. Custom sizes from 1" to 12" can be used.
Power	100-240 VAC, 50/60 Hz, 1.1A
Operating Temperature	0° C to 40° C/32 ° F to 104 ° F humidity 5% to 95% non condensing
Storage Temperature	-20° C to 70° C with humidity from 5% to 95% non -condensing
Network Interface	Ethernet 802.3 10/100 MB RF optional 802.11 abg
Processor	Xscale PXA-270
Memory	Minimum 64 Megabyte SDRAM
Mass Storage	Minimum 1 GB Compact Flash
Available COMM port	External load cell
RJ12	External load cell power
USB Port	For mouse, keyboard, Licensed USB flash drive





**WARNING**

**ELECTRICAL SHOCK HAZARD**

Connect to a properly grounded outlet only. Do not remove the ground prong. Power outlets must be easily accessible and located no further than the length of the power cord supplied with the product.

## Power

The power switch and power cord jack are located under the touchscreen on the left front of the scale.

Press **O** on the switch to turn the scale power to ON and again to turn the scale off (it is a momentary switch, so it will return to its original position after being touched). Always exit any editing screens before pressing the switch to turn power OFF. Always turn the scale off before cleaning.



The Impact M requires 100-240 VAC, 50/60 Hz, 2.2A power. Wiring must include a proper ground. The integrity of the power ground for equipment is important for both safety and dependable operation of the electronic device. A poor ground can result in an unsafe condition should an electrical short develop in the equipment.

A good ground connection minimizes extraneous electrical noise pulses. The electronic device should not share power lines with noise-generating equipment. Examples include electrical motors, compressors, heating elements, lights, and relays that may generate noise spikes and power surges. To confirm ground integrity, use a commercial branch circuit analyzer or grounded outlet tester. If adverse power conditions exist, a dedicated power circuit or power line conditioner might be required.

## Network Connection

The Impact M can connect to your Ethernet network using a cable or using a wireless radio. If you use a wired network connection and experience connection problems, make sure your Ethernet cable is connected and seated securely in the jack, located under the touchscreen at the front of the scale.

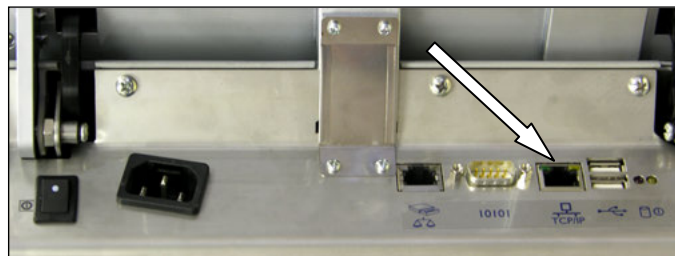

**Ethernet port**

If you are using a wireless radio, it is built into the scale under an access panel situated below the platter and spider on the left-hand side.

If the scale has a wireless card installed, do not connect an external Ethernet cable to the Ethernet port.

## Leveling the Scale

The Impact M must be level and installed on a stable counter. The level indicator is located behind the customer display, as shown below.



**Level Indicator**

The bubble in the indicator must be centered inside the circle. If the bubble is outside of the circle on the indicator, use the four leveling feet to level the scale.

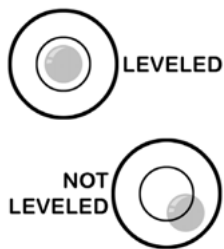

The level indicator consists of a bubble and two circles. Center the bubble and the scale will be level.



**Leveling Feet**

Rotate leveling feet clockwise or counterclockwise to determine a level platter.

# 2

## Operating Instructions

### Main Screen

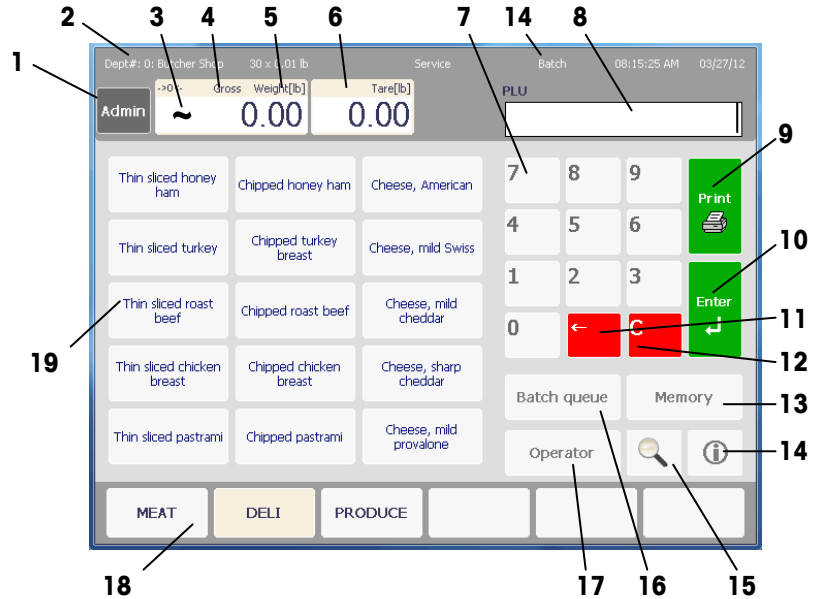

**NOTE:** the operator display is a touchscreen. Press the keys displayed on the screen only with your fingertips.

**DO NOT** use any sharp objects on the touchscreen. This could cause permanent damage to the touchscreen.

1	<b>Admin</b> – Opens the administration screen.
2	Department – shows the current department for the PLU database.
3	~ When this symbol displays, the weight on the scale is fluctuating.
4	<b>Net/Gross</b> when NET displays, it indicates a tare weight has been taken.
5	Weight Display shows the current weight and unit of measure (kg/lb). Touch the weight to zero the scale if it does not display 0.00 or 0.000.
6	<b>Tare</b> – Displays the current tare in use.
7	<b>Keypad</b> for entry of numerical data.
8	<b>PLU</b> – Displays the keypad entries as they are entered.
9	<b>Print</b> – Prints a label.
10	<b>Enter</b> - Accepts changes and returns to the previous screen.
11	← Backspace – deletes characters to the left of the cursor.
12	<b>Clear</b> – clears all data in the entry field.
13	<b>Memory</b> - stores transactions for use in printing a receipt-type label. When transactions are in memory, the word MEM will appear.
14	<b>I</b> – Information and Help.
15	<b>Search</b> - Used to search the PLU records for specific PLUs.
16	<b>Batch Queue</b> - Used to print multiple labels in one batch. When transactions are in queue, the word 'Batch' will appear at the top of the display.
17	<b>Operator</b> – Additional operator functions such as Quick Edits, Voids, display settings.
18	Preset Page Buttons. Selects the preset Page to use.
19	Preset Keys. Used for one-touch calling of PLU records or another page.

## Operator Screen

When the Operator button is pressed, the Operator screen displays with additional functions the operator can utilize.

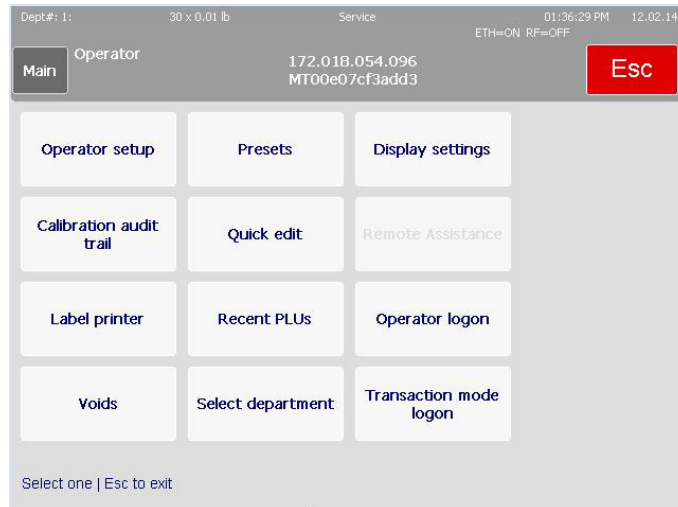

## Operator Setup

The following functions are available on the Operator Setup screen.

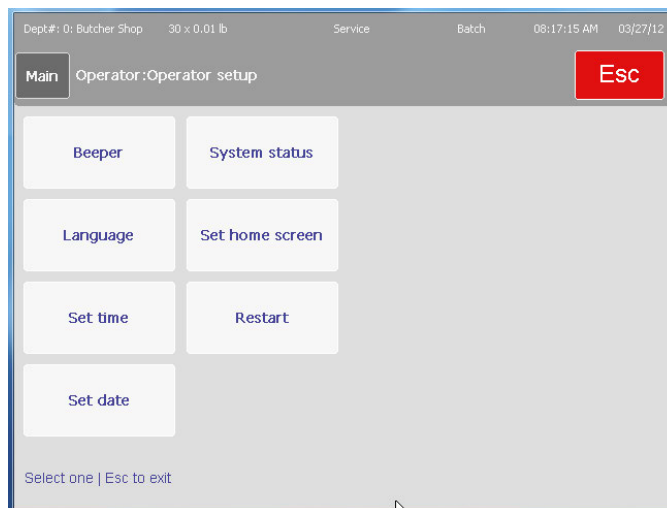

### Beeper

Select from Disable, or 1-5, to set the duration of the beeper when a button is pressed.

### Language

Select the Scale Language, Operator Language, and External Keyboard Language. Selections include English, Español, or Français.

### Set Time

Set the scale internal clock, hours, minutes, AM/PM.

### Set Date

Set the scale internal date.

### System Status

Show the system details, logs, and log levels.

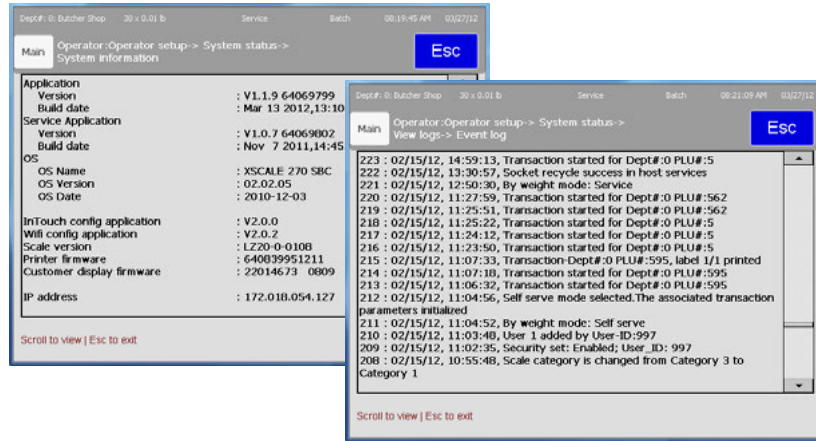

### Set Home Screen

Select the screen that displays as a default on power up and when returning from other screens.

### Restart

Performs a restart of the system, similar to pressing the power switch off and on.

## Calibration Audit Trail

This function will display a calibration log for technicians or Weights and Measures officials to use.

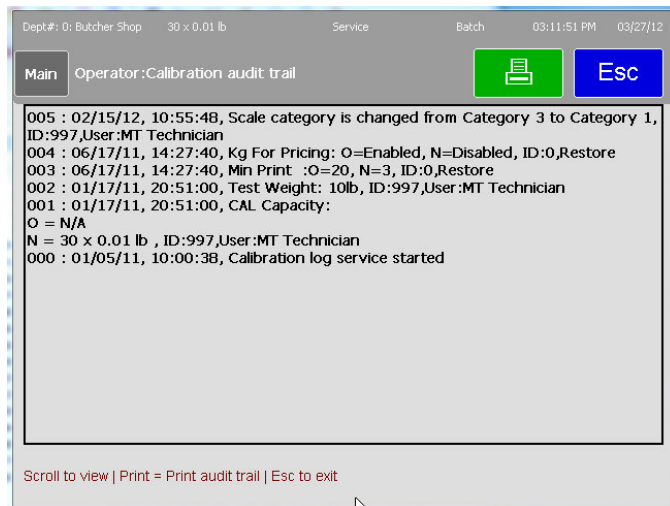

## Label Printer

The Label Printer screen allows setting label size, delivery mode, length and the functions Measure and Print Test Label.

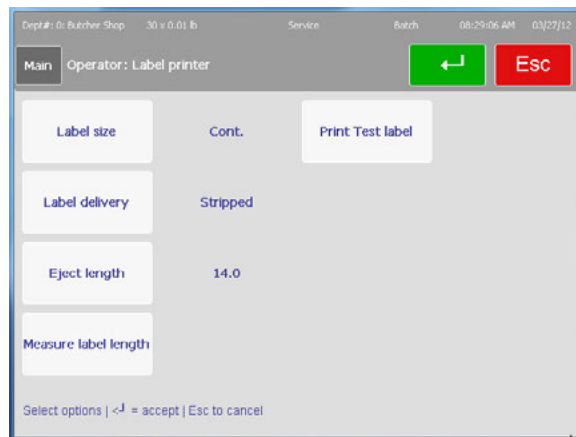

Select the label size from the list using the Label Size button. Select stripped or unstripped label delivery. In stripped mode, the liner is wound on the takeup roller and the label is ejected peeled from the liner and ready to put on a package. In unstripped mode, the liner and label are ejected out the front and can be peeled from the liner later. Eject length adjusts the label stop position after it is printed. This may need to be increased or decreased in order to stop in the center gap.

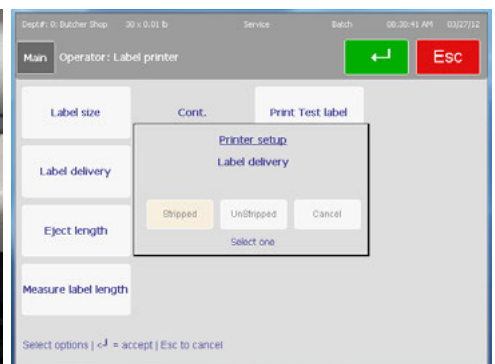
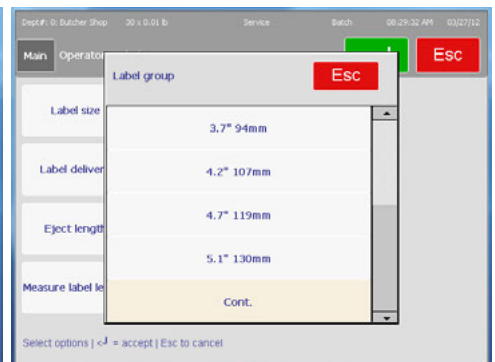
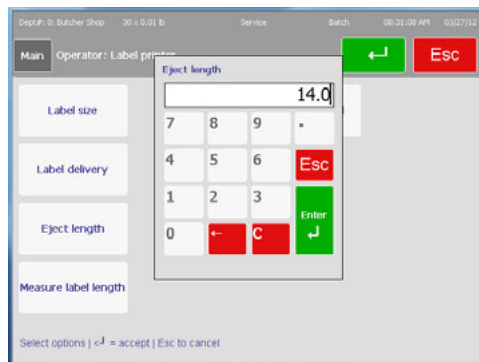

**Label Delivery Modes**



## Voids

To void a transaction, press the Voids button. Touch the transaction to void, then press the Void button.



## Presets

The Presets button opens a Preset Editor. In the editor, new presets can be created and existing presets edited, moved, or deleted.

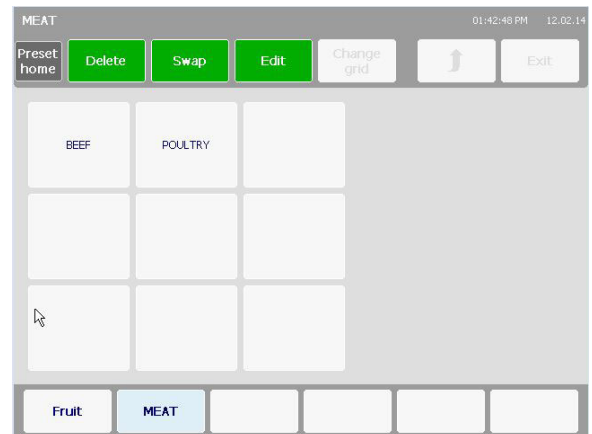

### Create Preset

To create a new preset, touch one of the empty buttons. A prompt will ask "Create PLU Preset" or Create Preset Page.

Create PLU preset creates a new button to call a PLU record. Create preset page will create a link to a new page of presets.

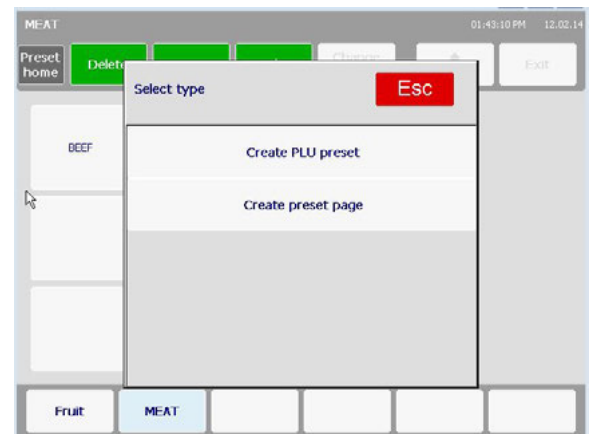

When creating a new PLU preset button, key in the department number and press Enter.

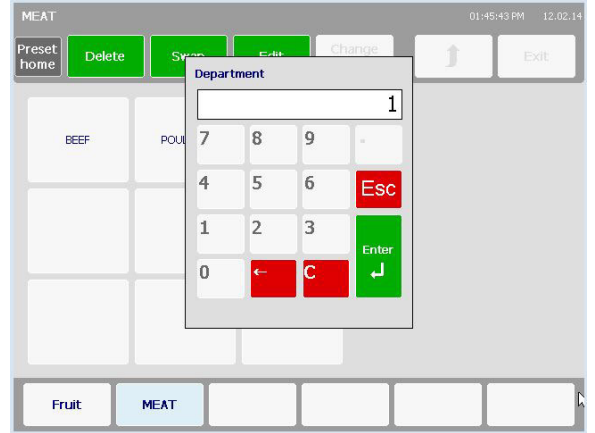

Next, key in the PLU number and press the Enter button.

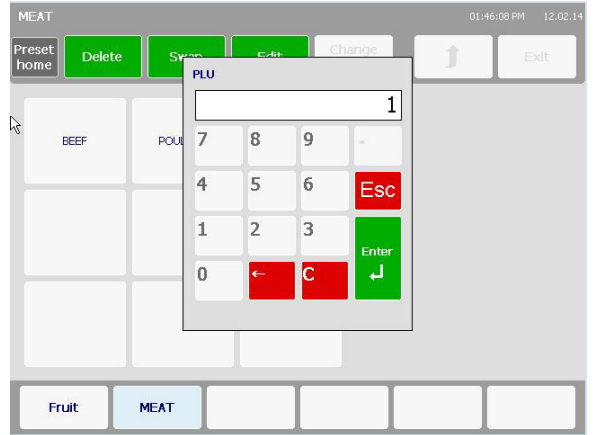

Edit the name that will be used on the button and press the green enter button to save and exit.

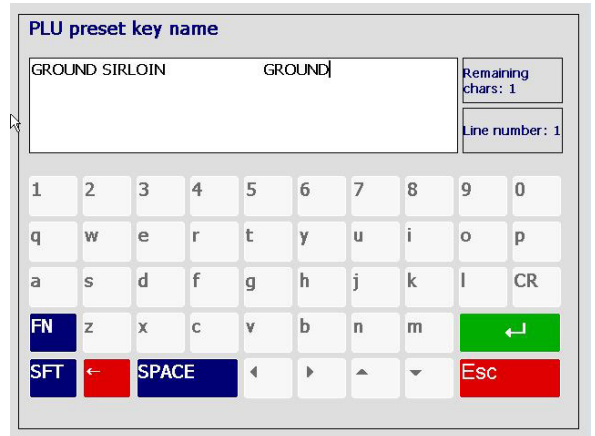

Last, you will be prompted to select a graphic (if Preset Type is set to Graphical Preset in Unit Setup->Scale Setup->Preset Settings) from a list of those available. If applicable, choose a graphic, than press enter. If there is not an applicable graphic, press enter without selecting a graphic and only text will display on the PLU Preset button.

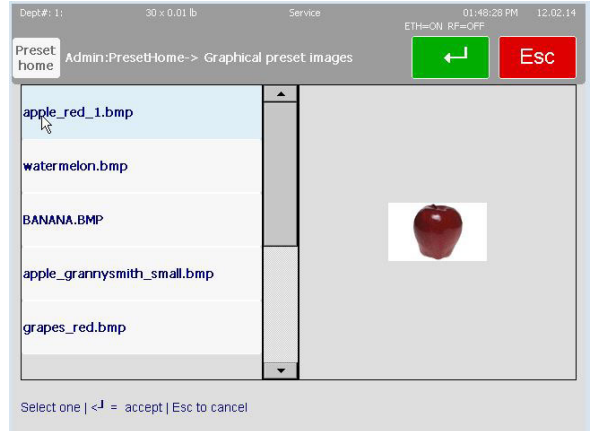

**Create Page**

To create a new page, touch a blank button and select Create Preset Page.

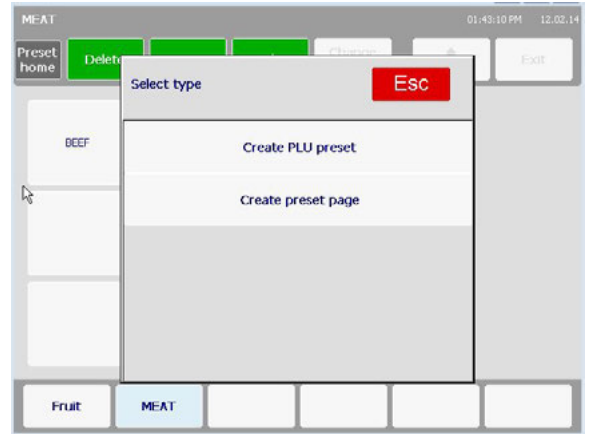

Type in the page name and press the green enter button to save and exit.

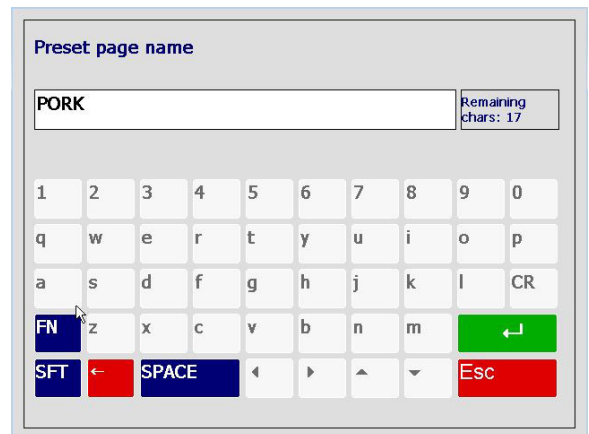

### Swap Presets

To swap preset positions, first press the Swap button and then press the first Preset to be swapped.



Next, press the Swap button again and then the second Preset to swap.

Press yes to continue with the swap or No to cancel.

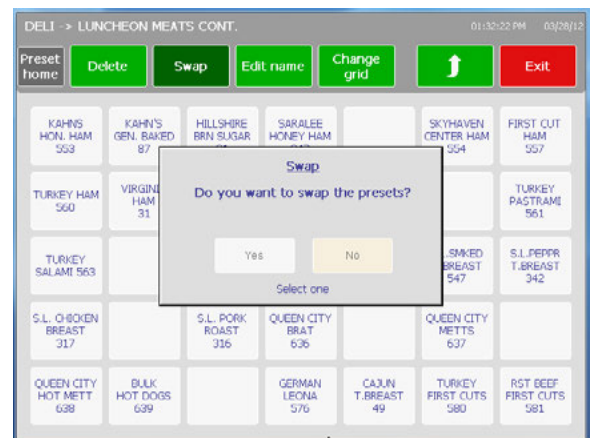

A confirmation window will open confirming the swap completed successfully.

Press Continue and press the green Save button at the top of the screen to save any changes made in the editor.

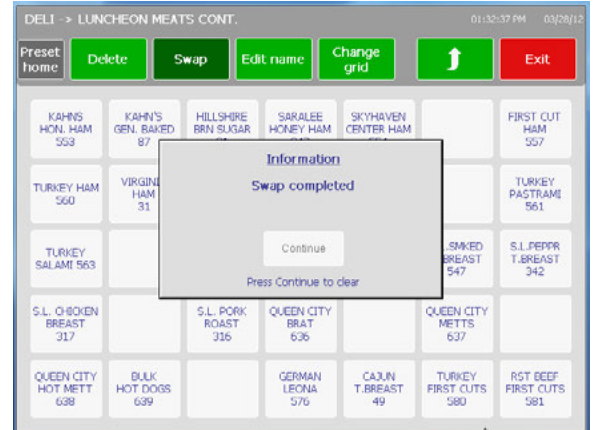

**Delete Preset**

To delete a preset, press the Delete button and then the Preset to delete.

Press Yes to confirm and delete or No to abort.

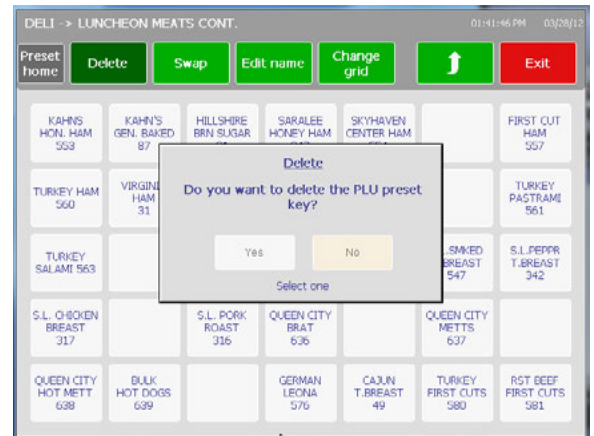

**Quick Edit**

Quick Edit allows editing of certain fields in the PLU record database. This function may be disabled and depends on the configuration of the scale.

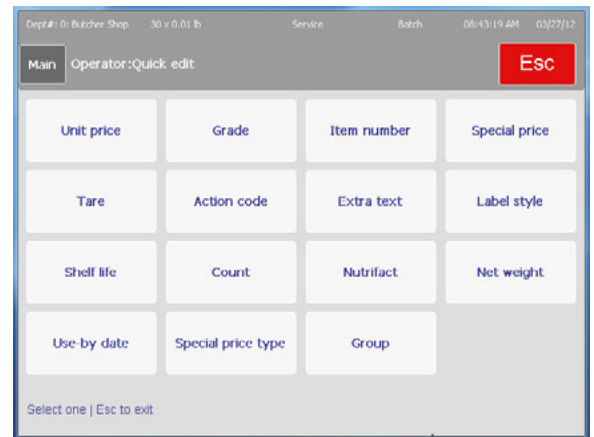

Press any of the field buttons and then enter the PLU number.

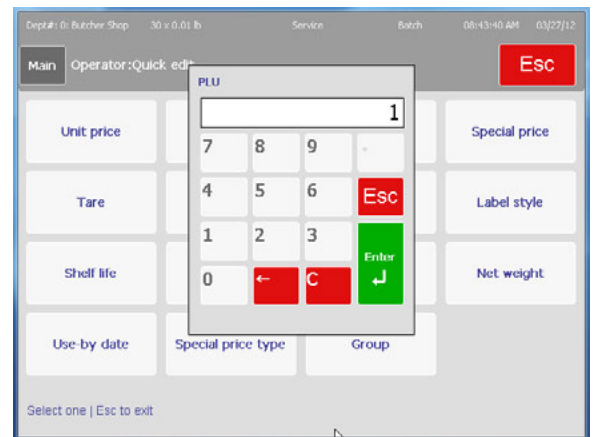

Enter the new value for the field and press the Enter button to save or ESC to cancel.

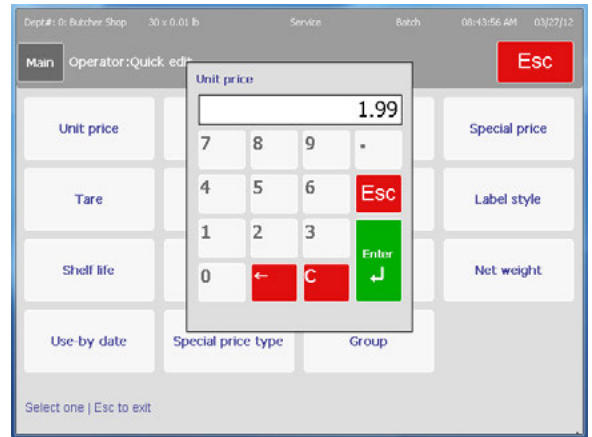

## Recent PLUs

To view a list of recent PLUs, press the Recent PLUs button.

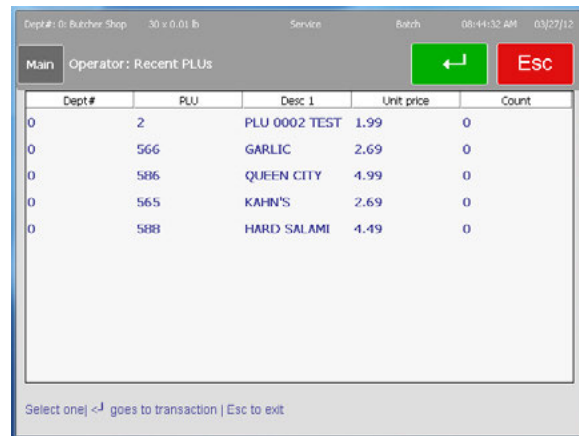

## Select Department

To select the default department, press the Select Department button. PLUs entered through the keypad will automatically search this department.



## Display Settings

The contrast on the customer display can be adjusted for the best viewing angle. Valid entries are 1-1023. Contrast 1 is darkest, Contrast 1023 is lightest. Brightness can be entered from 1-99. Brightness 1 is darkest, Brightness, 99 is lightest.

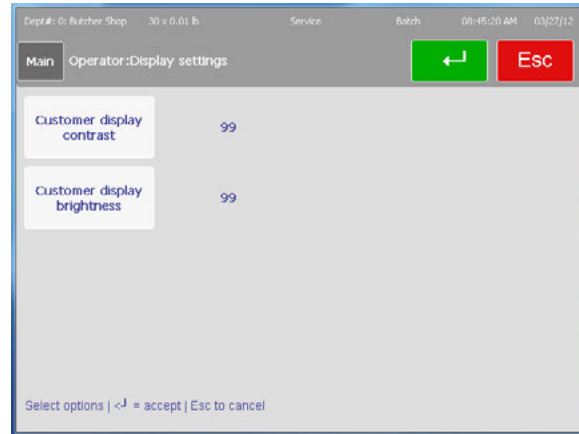

## Remote Assistance

Available in future version.

## Operator Logon

If Operator Mode Logon is enabled in Admin->Unit Setup->Scale Settings->PLU Access Parameters->Transaction Options, an Operator must log on to the scale to print a label. In addition, the Operator ID will be recorded in the transaction log with each transaction. This allows for better security and transaction traceability by operator. When the Operator Logon button is selected, operators will be prompted to enter their logon information. Once logged on, the operator will remain logged in until they log off or until the time between transactions exceeds the transaction mode timeout defined in Scale Settings.

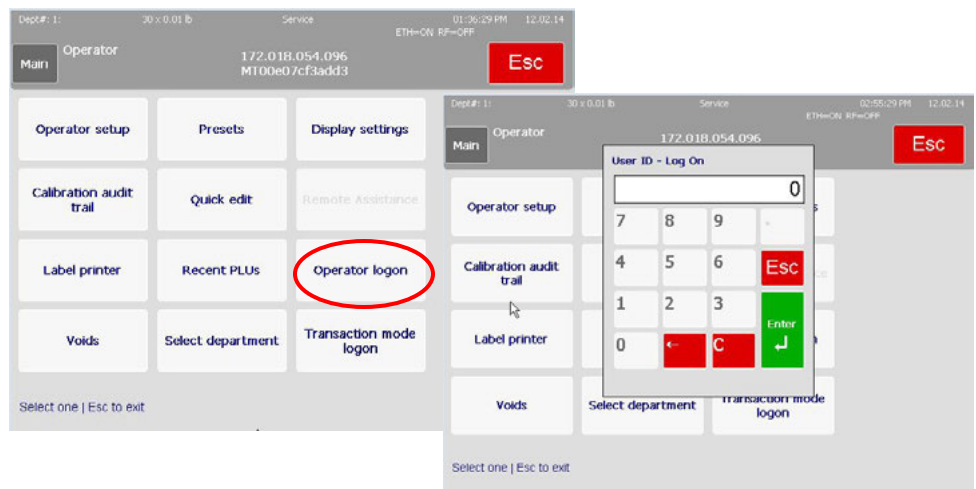

When selected again, operators will be prompted to log out.

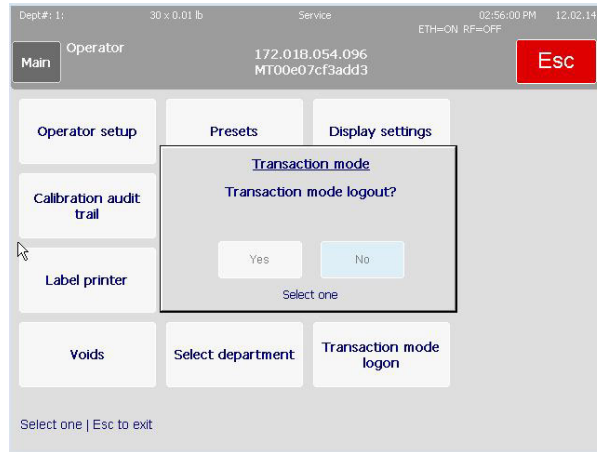

---

## Transaction Mode Logon

Transaction Mode Logon allows users to logon to preconfigured modes that are designed to run certain functions (ex. A Markdown mode that discounts the transaction by a certain % or a Rewrap mode that applies a % off discount, changes the label format, and changes the sell by date). When logged into this mode, all transactions will run these functions until the operator logs out of this mode.

The available modes are defined in Admin->Unit Setup->Scale Settings->Transaction Settings->Transaction Mode Configuration. For more information, review the section in this User's Guide on Transaction Settings.

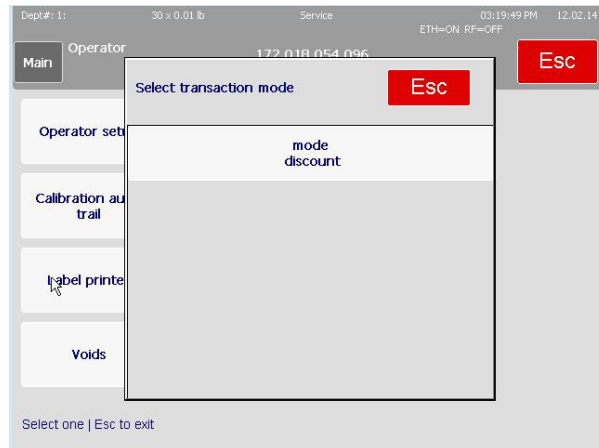



## Customer Display

The Customer Display can show different display screens based on the operation mode the scale is in. The different options are **By Weight PLU**, **By Count PLU**, **Standard Pack PLU**, **Weight Displayed/Weight at Zero/No PLU** and **Weight at Zero/No PLU** with a marquee message. A slide show can be configured to display when the scale is idle. Refer to the Marquee section in Chapter 3 for details.

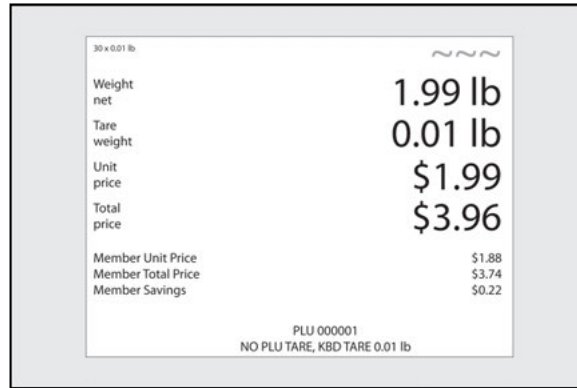

Customer Display – By Count PLU

## PLU Pricing Modes

PLU is an abbreviation for **Price Look Up**. The PLU is a reference number assigned to a product's record including fields such as the description, price, tare, etc. Different PLU's will have different pricing modes. Meat is normally sold "By Weight" by the pound or kilogram. Many bakery products are sold "By Count". Other products may be sold in a standard package that uses a fixed weight. The different pricing modes are as described in the following sections.

## By-Weight PLU

Examples of products sold **By Weight** are meats, cheese, poultry, and produce. By-Weight items can be priced in three ways:

**Priced "Per Pound/kg"** - Typically weighed items are priced per pound. The weight multiplied by the unit price equals the total price of the product.

**Priced "Per Fraction of a Pound/100g"** (fractional) - The item may also be priced by the fraction of the pound (where legal and desired). Pricing per 1/4 pound and per 1/2 pound are available in "pounds" mode and 100 gram is available in "kg" mode.

**"Pounds/kg for price"** - The PLU may be sold with a pounds-for-price (rather than price per pound). For example, "2 pounds for \$1.00" rather than "\$0.50/pound."

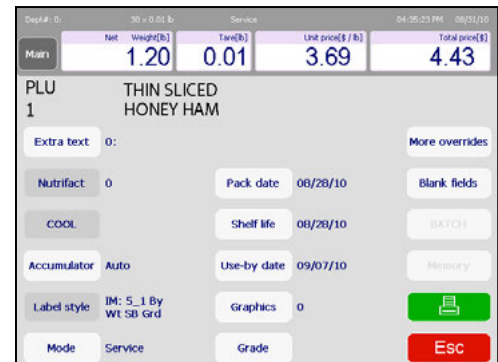

## By-Count PLU

Examples of items sold by the count are cookies, donuts, rolls, bread, etc. Example: 4 Apples for \$0.69. The By-Count PLU allows the operator to use the scale to print labels. Pricing is entered as a certain quantity of items for a set price. If the total weight for the items is needed, a weight field can be configured on the label to print the weight of the items in addition to the By-Count information.

The screenshot shows the By-Count PLU interface for 'WHOLE CHICKEN BREAST, MARINATED'. At the top, it displays '30 x 0.01 lb' and 'Service'. The main data fields are: Gross Weight [lb] (1.21), Count/Quantity (1), Unit price [\$/lb] (3.01), and Total price [\$\$] (3.01). Below this, the PLU code is 301. The interface includes several control buttons: 'Extra text' (0), 'Nutrifact' (0), 'COOL', 'Accumulator' (Auto), 'Label style' (IM: S\_1 By Cnt SB Grd), and 'No. of labels' (1). On the right side, there are 'More overrides', 'Pack date' (09/01/10), 'Shell life' (09/06/10), 'Use-by date' (09/13/10), 'Graphics' (0), and 'Grade'. A green 'Print' button and a red 'Esc' button are also visible.

## Standard Pack PLU

Examples of items sold by **Standard Pack** include whole chickens, sheet cakes, bread, etc. The Standard Pack PLU is similar to By-Count and also allows the operator to print labels. These labels indicate the fixed net weight and total price of the item. These types of items all use a fixed weight.

The screenshot shows the Standard Pack PLU interface for 'WHOLEWHEAT ENGLISH MUFFINS'. At the top, it displays '30 x 0.01 lb' and 'Service'. The main data fields are: Gross Weight [lb] (0.00), Count/Quantity (1), Net weight [oz] (4.0), and Total price [\$\$] (5.00). Below this, the PLU code is 500. The interface includes several control buttons: 'Extra text' (0), 'Nutrifact' (0), 'COOL', 'Accumulator' (Manual), 'Label style' (IM: S\_1 Std Pk SB Grd), and 'No. of labels' (1). On the right side, there are 'More overrides', 'Pack date' (09/01/10), 'Shell life' (09/01/10), 'Use-by date' (09/01/10), 'Graphics' (0), and 'Grade'. A green 'Print' button and a red 'Esc' button are also visible.

## PLU Screen Details

Dept#: 0: Engineer **05** 30 x 0.01 lb Service Online 1 01:07:23 PM 09/17/10

01	Net	Weight[lb]	02	Tare[lb]	03	Unit price[\$ / lb]	04	Total price[\$]
Main		1.20		0.50		1.02		1.22

**07** LU PLU # 1 \$ 1.01  
1 DEPT # 0000 TARE 004

**19** Extra text 0: **13** More overrides

**20** Nutrifact 2 **08** Pack date 09/17/10 **14** Blank fields

**21** COOL **09** Shelf life 09/20/10 **15** Esc

**22** Accumulator Auto **10** Use-by date 09/24/10 **16** BATCH

**23** Label style IM: 5\_1 By Wt SB Grd **11** Graphics 0 **17** Memory

**06** Mode Service **12** Grade GRADE 3 **18** [Print]

PLU Screen Components	
1	<b>Net weight</b> the weight of actual goods, excluding packing materials. The scale will automatically determine Kg or Lb or Count depending on the PLU item type.
2	<b>Tare</b> displays the tare value assigned to the PLU transaction.
3	<b>Unit price</b> is programmed into the PLU record. If allowed, touch to override. This is used to calculate the Total Price.
4	<b>Total price</b> of the item. If the item is sold by weight, this is the unit price multiplied by the weight of the item. The Total Price is never operator accessible.
5	<b>Net/Gross</b> when NET displays, it indicates a tare weight has been taken.
6	<b>Mode</b> states the mode of Operation: Service, or PrePack.
7	PLU number and description.
8	<b>Pack date</b> displays the current date.
9	<b>Shelf life</b> displays the date programmed into the PLU. The item should <b>NOT</b> be sold beyond this date.
10	<b>Use-by date</b> shows the date after which the product should no longer be consumed.
11	<b>Graphics</b> allows the user to select a printed graphic from the unit's archive.
12	<b>Grade</b> designates a "grade" for the product described by the PLU
13	<b>More overrides</b> accesses a menu that holds overrides not described by the buttons
14	<b>Blank fields</b> accesses a list of flags that determine whether a certain parameter will appear on the printed label
15	<b>ESC</b> returns to the previous screen without printing a label
16	<b>Batch</b> is used to print multiple labels in one batch When in Batch mode with transactions in queue, the word <b>Batch</b> will appear.
17	<b>Memory</b> is used to store transactions for use in printing a receipt-type label. When transactions are in memory, the word <b>MEM</b> will appear.

18	<b>Print</b> – prints a label that references the given information
19	<b>Extra Text</b> allows the user to select from the unit's extra text records
20	<b>Nutrifact</b> allows the user to select from a list of existing nutritional fact entries
21	<b>COOL</b> displays the PLU's COOL data
22	The <b>accumulator</b> button allows the user to set specific accumulation settings for the PLU
23	<b>Label style</b> displays the currently selected label style

## Calling PLUs

When the Impact M is in **Service** mode, the operator screen will display the active department's Preset Pages and Preset PLUs.

**Note:** **Service** mode is the default on the PLU Edit screen. After the product has been weighed, a label has been printed, and the item has been removed from the scale, the PLU will clear and the scale will return to the home screen.

Net	Weight [lb]	Tare [lb]	Unit price [\$/lb]	Total price [\$.]
1.20	0.50	1.02	1.22	

PLU # 1 \$ 1.01  
DEPT # 0000 TARE 004

Extra text 0: More overrides

Nutrifact 2 Pack date 09/17/10 Blank fields

COOL Shelf life 09/20/10 Esc

Accumulator Auto Use-by date 09/24/10 BATCH

Label style IM: 5\_1 By Wt SB Grd Graphics 0 Memory

Mode Service Grade GRADE 3

To begin a transaction, place an item on the weighing tray (can be done either before or after a PLU is called up).

Call a PLU (Price Look Up) by pressing the Preset key related to the product directly enter the PLU number on the keyboard.

The screen will vary slightly in appearance depending on whether it is By Weight, By Count or Standard Pack. Depending on how the PLU has been set up, some of the fields may be over-ridden such as Shelf Life, Tare, etc.

## Printing Labels

### By Weight PLU

Once the **By Weight** PLU has been called up, make any needed changes by pressing the buttons for allowed fields, and then press the **Print** button to print a label.

Take the label and remove the item from the scale to complete the transaction. The screen will return to the home screen, unless the Prepack Mode is selected using the Mode button. Press the Mode button to toggle between Service and Prepack. In Prepack Mode, the PLU will be retained. Prepack Mode is designed to weigh multiples of the same item.

Net	Weight[lb]	Tare[lb]	Unit price[\$ / lb]	Total price[\$]
1.20	0.50	1.02	1.22	

PLU 1 PLU # 1 \$ 1.01  
DEPT # 0000 TARE 004

Buttons: Extra text 0: More overrides, Nutrifact 2, Pack date 09/17/10, Blank fields, COOL, Shelf life 09/20/10, Esc, Accumulator Auto, Use-by date 09/24/10, BATCH, Label style IM: 5\_1 By Wt SB Grd, Graphics 0, Memory, Mode Service, Grade GRADE 3, Print icon

**Service Mode** – Best for weighing different single items. Enter the PLU number, place the item on the platter, and then press the Print button for a label. When the product is removed from the platter, the screen will clear and return to home ready for the next PLU.

**Prepack Mode** – Best for weighing multiples of the same item. To use, enter the PLU number or press a preset, place the item on the platter and a label will issue automatically. Remove the item from the platter and place the next item (of the same type) on the platter for the next label. When done, press the Clear button to return to the home screen.

The Service and Prepack mode print button can be configured in the Unit Setup, Scale Settings, Scale Modes screen. See Chapter 3 for additional information.

Scale mode	Service
Service mode print after motion	No
Service mode print key always active	No
Prepack mode print after motion	Yes
Prepack mode print key always active	Yes

Select options | < = accept | Esc to cancel

## By Count PLU

Once the **By Count** PLU has been called up, make any needed changes, and then press the **Print** button to print a label.

**Note:** if the count is different than what is programmed into the PLU record, press the Count/Quantity box, enter the new quantity, press **Enter** and then press the **Print** key to print the label.

Main		Gross Weight[lb]	Count/Quantity	Unit price[\$ / lb]	Total price[\$]
		1.70	3	0.33	1.00
PLU 310		PISTACHIO MUFFINS, 3 ct. DEPT #0008			
Extra text	10100: CONTAINS NUTS OR INGREDIENTS THAT MAY HAVE COME INTO CONTACT WITH NUTS			More overrides	
Nutrifact	0	Pack date	09/17/10	Blank fields	
COOL		Shelf life	09/17/10	Esc	
Accumulator	Auto	Use-by date	09/17/10	BATCH	
Label style	IM: 5_1 By Cnt SB Grd	Graphics	0	Memory	
No. of labels	1	Grade		Print	

Take the label and remove the item from the scale to complete the transaction.

## Standard Pack PLU

When a **Standard Pack** PLU has been called up, make any needed changes, enter the number of labels needed (with the lower-left button of the same name) and then press the **Print** button.

**Note:** if the count is different than what is programmed into the PLU record, press the Count/Quantity box, change the amount, press **Enter** and then press the **Print** key to print the label.

Main		Gross Weight[lb]	Count/Quantity	Net weight[oz]	Total price[\$]
		0.00	1	501.0	4.54
PLU 454		ROAST CHICKEN BREAST			
Extra text	0:	More overrides			
Nutrifact	0	Pack date	09/17/10	Blank fields	
COOL		Shelf life	09/17/10	Esc	
Accumulator	Auto	Use-by date	09/17/10	BATCH	
Label style	IM: 5_1 Std Pk SB Grd	Graphics	0	Memory	
No. of labels	1	Grade		Print	

Take the label and remove the item from the scale to complete the transaction.

## Temporary Overrides

Temporary Overrides are certain values can be changed for the **current transaction only** from within the PLU screen. The changes are temporary and will not be retained in the original PLU database.

If a value can be changed it will appear with a white border around the button with contrasting text. This indicates that the value can be changed during a transaction.

The screenshot shows a PLU screen with the following data and controls:

Net	Weight[lb]	Tare[lb]	Unit price[\$ / lb]	Total price[\$]
1.20	0.50	1.02	1.22	

PLU # 1 \$ 1.01  
DEPT # 0000 TARE 004

Buttons and fields shown:

- Extra text: 0 (grayed out)
- Nutrifact: 2 (grayed out)
- COOL (grayed out)
- Accumulator: Auto (grayed out)
- Label style: IM: 5\_1 By Wt SB Grd (grayed out)
- Mode: Service (grayed out)
- Pack date: 09/17/10 (white border, dark text)
- Shelf life: 09/20/10 (white border, dark text)
- Use-by date: 09/24/10 (white border, dark text)
- Graphics: 0 (grayed out)
- Grade: GRADE 3 (grayed out)
- More overrides (white border, dark text)
- Blank fields (white border, dark text)
- Esc (red button)
- BATCH (grayed out)
- Memory (grayed out)
- Print icon (green button)

In the PLU screen above, for example, the **Pack date**, **Shelf life** and **Use-by date** (and many more) are represented as buttons with white borders and dark contrasting text, indicating they can be changed. Buttons grayed out indicate the value cannot be changed.

To change a value, touch the field. Then, depending on the field, enter a numeric value in the pop-up window using the keypad, toggle to a different choice within the selected field or, if there are multiple choices, a new screen will appear and a selection can be made from there.

Additional overrides not shown on the screen can be found by pressing the **More overrides** button in the upper right-hand corner of the screen.

## Memory Mode

To use **Memory Mode**, press the **Memory** key instead of the Print key. This will store the transaction data into Memory Mode and return to the Home screen.

If a PLU is added to MEMORY that already exists in MEMORY, it is treated as a separate entry. This means that it is possible to have multiple transactions associated with the same PLU.

To edit or complete the transaction, press the Memory button at the home screen. Functions available include **Subtotal**, **Remove Item** and **Clear Mem**.

To remove an item, press the "Remove Item" button and select the item to be removed. To completely clear and cancel the transaction, press the "Clear Mem" button.

To complete the transaction, press the Subtotal button. From this screen, a receipt label can be printed.

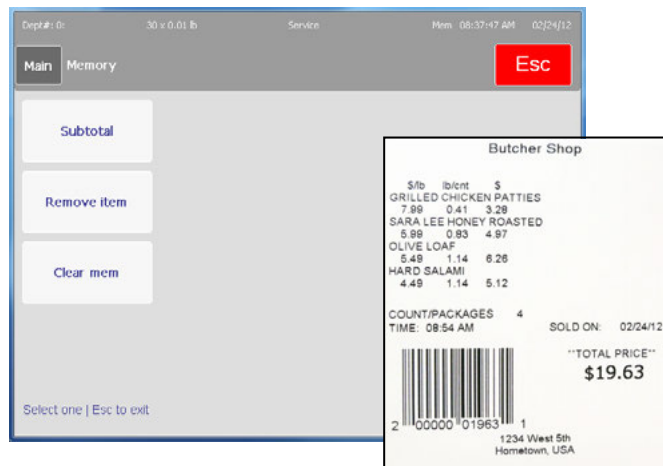

To enable memory mode, a supervisor or technician can access this function under Unit Setup. Scale Settings. In order to use Department mode, the scale must be configured as a client.

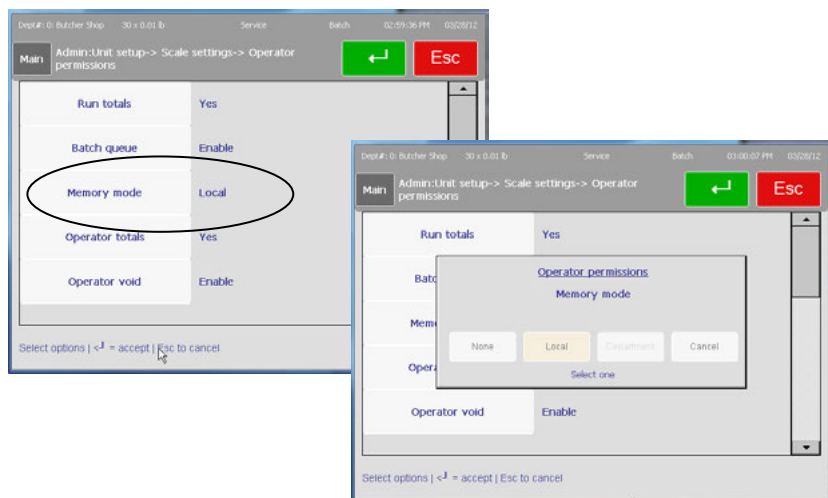



## Batch Queue

Batch Queue Mode is used to print batches of labels. The PLU records must be By-Count or Standard Pack. Batch will not work with Random Weight type PLU records. In addition, Batch Queue must be enabled in Admin/Unit Setup/Scale Settings/Operator Permissions.

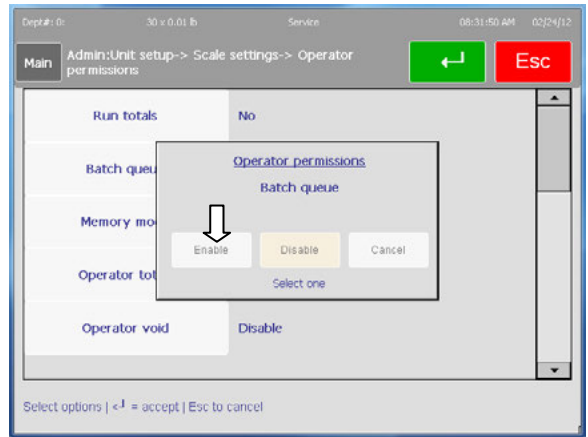

To use Batch Queue, first call up a By-Count or Standard Pack PLU. Press the Batch button to enter it into the queue. Several PLU records can be entered into the queue before printing the labels.



You will see a message box pop up indicating the record has been added to the queue. The batch indicator will display on the top right of the screen indicating a batch is in progress. The screen will return to home and you can then enter another PLU. When you are ready to print labels, press the Batch button from the home screen.

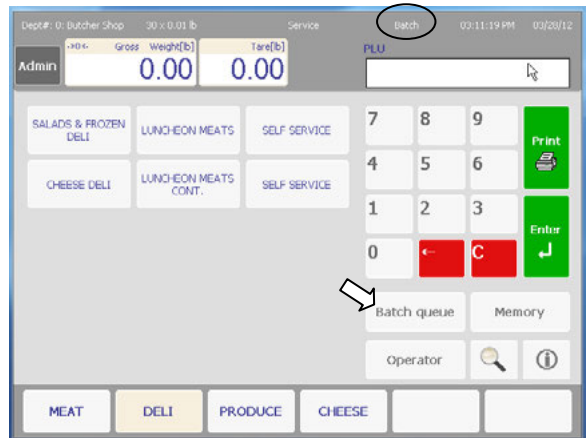

The View Batch Queue screen will open. From this screen, you are able to Delete Item, Clear Order, Change Label Quantity, and print.



If you are printing labels in a stripped mode, the printer will issue one label at a time. The next label will print when the printed label is removed from the printer. If the printer is loaded in un-stripped mode, the quantity of labels entered will print.

## Self Service Mode

Self Service mode allows placing the Impact M in an area where the customer may weigh the product and print price labels for the product. In this mode, areas other than PLU retrieval and printing are restricted. Refer to Chapter 3 section Self Service Mode Setup for details on configuring the Self Service mode. The Self Service main screen is shown below.

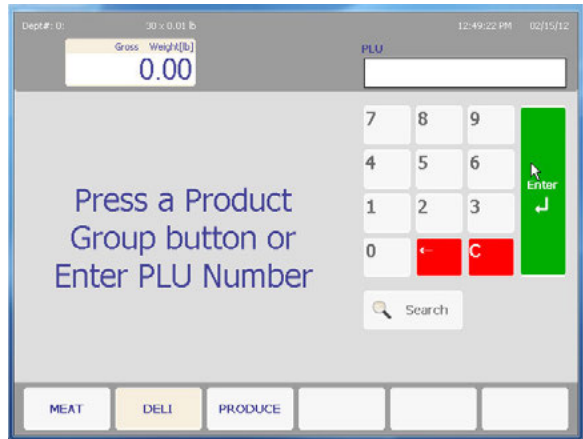

PLU's can be retrieved using the keyboard, search, or preset keys.

Touch a category to select the preset group. Presets can call up individual PLU records or pages. In the example below, the Category "Deli" is displaying pages available under that category.



Once a page is selected, the Preset Keys allow quick PLU access.

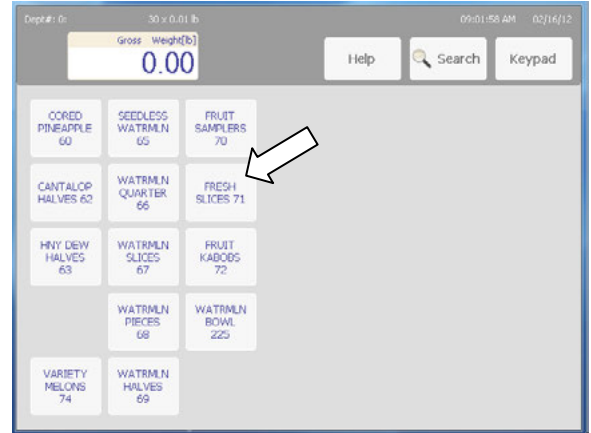

If no activity is detected for several minutes, the screen will return to the main screen. Touching the Keypad key will also return to the main screen.

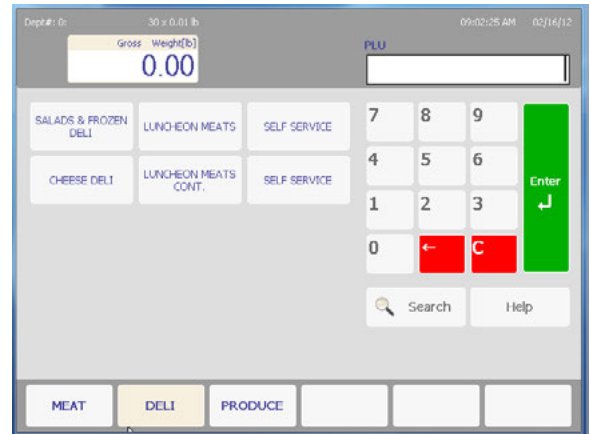

## COOL

If the PLU has a COOL record programmed, it will show on the PLU screen.

Note: Refer to Chapter 3 COOL for additional details on COOL configuration.



## METTLER TOLEDO Impact M User's Guide

If COOL is forced, the operator will be required to choose and verify the COOL record. The MRU (Most Recently Used) will display at the top and can be selected by pressing the box. To select a different COOL record, press one of the other selections listed. Press the green Enter button when finished to continue.



# 3

## Admin Functions

### Admin Button

Setup for the Impact M is through the **Admin** screen, accessed by pressing the **Admin** button in the upper left of the touchscreen.

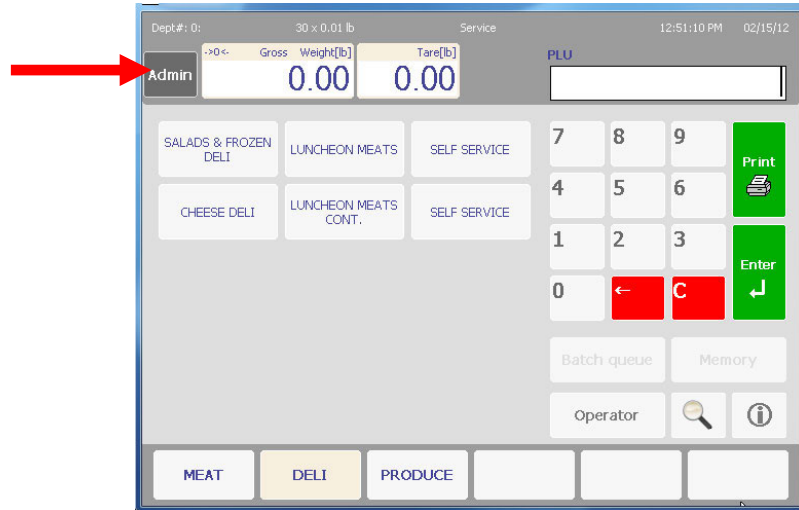

From here the Item Database, Preset, Labels, Unit Setup, Security, Printer Setup, System Status, Quick Edits, Select department and Marquee settings can be accessed and modified.

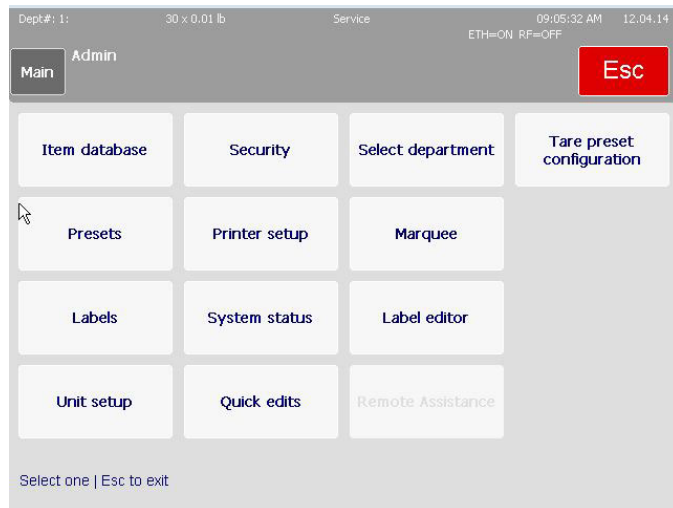

## Item Database

The **Item Database** screen is used to modify PLU files and associated files such as Extra Text, Nutrifacts, etc. The database editor will look different depending on whether the Impact M is set up as a client or standalone. This section will describe the Standalone Mode Database Editor. When the Impact is set up in client mode, it will be accessing the REM Master Editor. For additional details for the client mode, refer to the REM Master User's Guide.

## Item Database Editor



Optional USB keyboard is recommended.

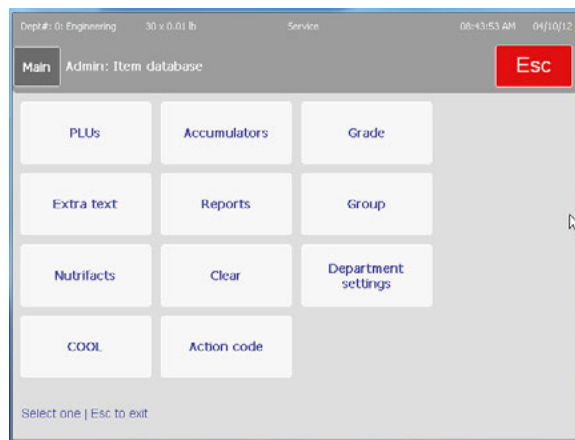

**Standalone Mode Database Editor**

This screen allows access to the different fields in a PLU record.

**PLUs** – this button takes the user to a very specific list of editable PLU features

**Extra Text** – used to view and edit the Extra Text displayed with a PLU

**Nutrifacts** – allows enabling/disabling of the embedded PLU nutrifacts

**COOL** – change, force or disable COOL data on a per-PLU basis

**Accumulators** – view and modify the accumulator lists

**Reports** – allows viewing of the various unit reports

**Clear** – used to delete entries from various databanks

**Action Code** – enable, disable, add or modify action text

**Grade** – used to edit or add grade information to PLU entries

**Group** – used to edit or add groups to the database

**Department Settings** – allows the configuration of various department settings

## REM Master Editor

In client mode, the Impact M will access the Master Editor in the REM. An example Master Editor screen is shown below. Refer to the REM Master User Guide for additional information.



## PLUs

The **PLUs** function is used to edit all fields of a particular PLU. The data is arranged in a scrollable list and can be modified by touching the appropriate field and following the menu prompts. PLUs from any department may be edited by choosing the desired department number at the **DEPT. NUMBER** prompt. Press the green **Enter** button to save changes when done editing.

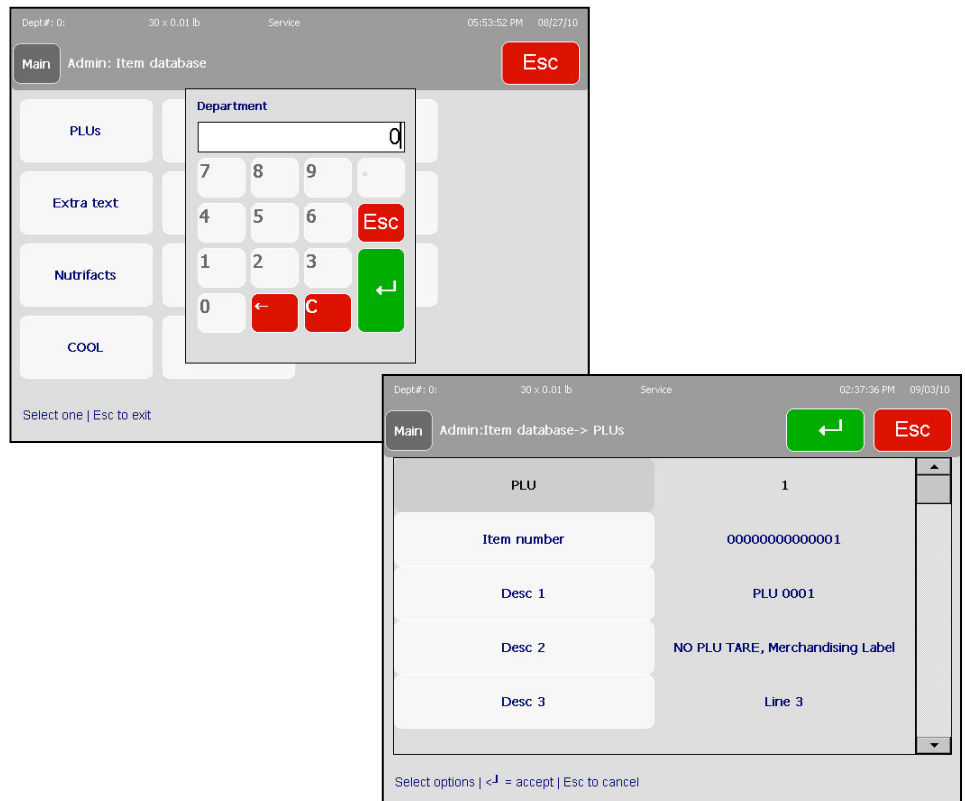

The fields in the PLU record consist of the follow items.

<b>PLU Number</b>	The PLU number can be from one to six digits (1-999999). Entering a new number allows entry of the field data. If the PLU currently exists, the current field data is displayed and can be modified.
<b>Item Number</b>	Used in the bar code data. The Item number can be from one to 10 digits depending on the barcode format.
<b>Desc 1</b> <b>Desc 2</b> <b>Desc 3</b> <b>Desc 4</b>	Up to four lines of description can be programmed for the PLU record, up to 32 characters per line. To delete a character, press the Backspace button. To delete the complete line, first press the Shift button, then press Backspace.
<b>PLU Type</b>	The PLU Type determines the pricing mode that includes PRICE PER POUND, POUNDS FOR, PRICE PER HALF POUND, PRICE PER QUARTER POUND, BY COUNT, STANDARD PACK, and MANUAL. The choice of PLU type affects some of the menu options for the PLU Edit screen. If a change in PLU type is made, the default value for the new option is assigned.
<b>Tare1/Ounces</b>	This field changes depending on the PLU type. For Price Per Pound, Price Per Half Pound, Price Per Quarter Pound, and Pounds For PLUs, this field is titled TARE1 and when selected presents a numeric keyboard for the entry of the tare weight (default = 0.00). For Std Pack PLUs, it is titled OUNCES and when selected presents a numeric keyboard for the entry of the number of ounces in a pack. For By Count or Manual PLUs, this field is blank and disabled.
<b>Tare 2</b> <b>Tare 3</b> <b>Tare 4</b>	This field changes depending on the PLU type. For Price Per Pound, Price Per Half Pound, Price Per Quarter Pound, and Pounds For PLUs, this field is titled TARE2 and when selected, a SELECT TARE2 TYPE screen is presented. Tare2 can be a fixed weight or forced so that the operator must enter the tare. A PERCENTAGE option is displayed but functions as the FIXED WEIGHT tare. If FIXED WEIGHT or PERCENTAGE are selected, a numeric keyboard prompts for the values of a tare weight (default=0.00). If FORCED is selected, the word FORCED appears in that field. This tare is available for the situation when 2 different tares are needed for the same product (ex. - with meat products, one tare is for the back room, and one tare is for the counter, after the meat has been re-packaged). For By Count, Standard Pack, and Manual PLUs, this field is blank and disabled.  If Tare2 is not used, press the CANCEL button to bypass this entry.
<b>Unit Price/Total Price</b>	This field changes depending on the PLU type. For Price per Pound, Price Per Half Pound, Price Per Quarter Pound, and Pounds For PLUs, this field is titled UNIT PRICE and when selected presents a numeric keyboard for the entry of the unit price (default = \$0.00). For By Count and Standard Pack, it is titled TOTAL PRICE and when selected presents a numeric keyboard for the entry of the total price (default = \$0.00). For Manual PLUs this field is blank and disabled.



<b>Shelf Life</b>	Enter the number of days from 0 to 999 (default = 0). This is added to the current date when calculating the Shelf Life. Select Blank to blank the date from the label or Force to require manual entry of this value by the scale operator.
<b>Use By Day</b>	Enter the number of days from 0 to 999 (default = 0). Select Blank to blank the date from the label or Force to require manual entry of this value by the scale operator.
<b>Group</b>	Enter the group number between 1-500, or None.
<b>Grade</b>	Grade number from 1-16, or None.
<b>Extra Text Number</b>	Enter the Extra Text number to use with this PLU from 1-999999, or 0 for none.
<b>Nutrifacts No</b>	Nutrition Facts number to use with this PLU or none.
<b>Graphics No</b>	Enter the number (1-999999) corresponding to a graphics image resident in the database.
<b>Action Code</b>	Enter the Action Code (1-50). An Action Code will perform specific functions when the PLU is called depending on the function selected when downloaded from a host.
<b>Barcode Type</b>	UPC, EAN, GS1
<b>Barcode Prefix</b>	Select 1-9 for the prefix.
<b>Random Weight Type Format</b>	<p>When a Type-2 UPC Bar Code is selected or if the Bar Code is configured as EAN, the format of the symbol must be configured, as follows: (N=Item Number, C=Price/Weight Check Digit, \$=Total Price, X=Bar Code Check Digit, #=Weight).</p> <p><b>UPC Formats</b></p> <p>0 = NNNNN C\$\$\$\$ X  1 = NNNNN O\$\$\$\$ X  2 = NNNNN N\$\$\$\$ X  3 = NNNNN \$\$\$\$\$ X  4 = NNNNN C#### X  5 = NNNNN O#### X  6 = NNNNN N#### X  7 = NNNNN ##### X</p> <p><b>EAN Formats</b></p> <p>0 = NNNNN N\$\$\$\$ X  1 = NNNNN \$\$\$\$\$ X  2 = NNNN\$ \$\$\$\$\$ X  3 = NNNNN C\$\$\$\$ X  4 = NNNNC \$\$\$\$\$ X  5 = NNNNN ##### X  6 = NNNNC ##### X</p>
<b>Blank Fields</b>	The Pack Date, Weight, Unit Price, or Total Price can be blanked (not printed) on the label. Touch the selection to toggle Blank or Normal.
<b>Label Style</b>	This field represents label styles 0-7 and will override the default label style for this PLU. Style 0 is the default format. Styles 1-7 will override the default style for a PLU.
<b>DayGlo Number</b>	Allows the user to select a Day-Glo graphic from a numbered list.
<b>Security Label</b>	Select either YES or NO to print as a security label

<b>Special Price Type</b>	Select the type of discount, or press None for no Frequent Shopper Pricing. List Price - (similar to a Mfg. Suggested List Price). The amount entered is always higher than the PLU unit price. Member Price - Discounted price for By-Weight, By-Count, or Std. Pack PLUs. Percent Discount - A percentage off the Total Price for By-Weight, By-Count, or Std. Pack PLUs. Discount Per Pack - This is a specific amount off the Package Total Price for By-Weight, By-Count, or Std. Pack PLUs. Discount Per Unit - This is a specific amount off the Unit Price for By-Weight PLUs. None - This disables Special Pricing. The value will default to zero and editing is disabled.
<b>Special Price</b>	Set a special price for the chosen PLU
<b>Portions</b>	Number of portions per package
<b>Force COOL</b>	Enforces COOL representation within the selected PLU.
<b>Tracking</b>	YES to apply internal reference tracking information for a specific COOL. Defaults to NO. Note: although internal, this tracking number can be placed on labels.
<b>COOL Text</b>	Custom COOL text linked records may be entered here
<b>Production Text</b>	COOL product text linked record number
<b>Country Text</b>	COOL Country text linked record number
<b>Pre Text</b>	COOL Pre Text linked record number
<b>TLV Text</b>	Tag Length Value reference number
<b>Large Graphics One Type</b>	Linked record options: Extra Text, Graphics Record, Large Graphic Tracked
<b>Large Graphics One Number</b>	Selected LG One linked record number
<b>Large Graphics Two Type</b>	Linked record options: Extra Text, Graphic Record, Large Graphic Non-Tracked
<b>Large Graphics Two Number</b>	Selected LG Two linked record number
<b>Pull Date</b>	Date to pull the product.
<b>Label Two Style</b>	Alternate Label Style
<b>Date Forwarding</b>	Allows entry of a future packing date. No disables future date entries.

## Extra Text



Optional USB keyboard is recommended.

The **Extra Text** function is used to modify the Extra Text records. There is a limit to the number of characters, and is shown in the box to the right of the type-field..

**Extra text**

INGREDIENTS- BONELESS BREAST OF CHICKEN, HAM, SWISS CHEESE, AND SEASONINGS. BAKE AT 375 FOR 20-25 MINUTES. UNCOVERED	Remaining chars: 3098
	Line number: 6

1	2	3	4	5	6	7	8	9	0
q	w	e	r	t	y	u	i	o	p
a	s	d	f	g	h	j	k	l	CR
FN	z	x	c	v	b	n	m	↵	
SFT	←	SPACE		→	↑	↓	Esc		

Type in the text and then press **Enter** to save and return to the previous screen. From there, you may edit other text records or return to the **Database** screen.

## Nutrifacts

Selecting the **Nutrifact** field will bring up a window that allows you to edit/add/delete Nutrifact records. After creating the Nutrifact record, it must be added to the PLU record and also the Nutrifact panel must be added to the label format in order to be printed on the label.

Dept#: 01    30 x 0.01 lb    Service    06:13:44 PM    08/27/10

Main    Admin:Item database-> Nutrifact    Esc

Edit existing

Add

Delete

Select one | Esc to exit

Dept#: 01    30 x 0.01 lb    Service    02:15:38 PM    02/21/12

Main    Admin:Item database-> Nutrifact    Esc

Edit existing

Add

Delete

Nutrifact

201

7	8	9	-
4	5	6	Esc
1	2	3	Enter
0	←	C	↵

Select one | Esc to exit

If the number is not recognized you may select "add" to create a new record.

**Label** – Select to print Nutrifact information on the main label in short-form or if print on a second label. Also select which of the two labels (if chosen) will be printed first.

**Template** – These choices select the correct template for the NF regulations and work with the NF Template setting in the Scale Settings. The setup in Scale Settings will over-ride the NF field settings when Meat NF formats are selected. Select from Vertical, Tabular, Linear Portrait, Linear Landscape, Meat NF 2011 Simplified Vertical Small Pkg, Meat NF 2011 Simplified Vertical Large Pkg, Meat NF 2011 Simplified Vertical Narrow, Meat NF 2011 Tabular Small Pkg, Meat NF 2011 Tabular Large Pkg, Meat NF 2011 Tabular Small Pkg Narrow, and Meat NF 2011 Tabular Large Pkg Narrow.

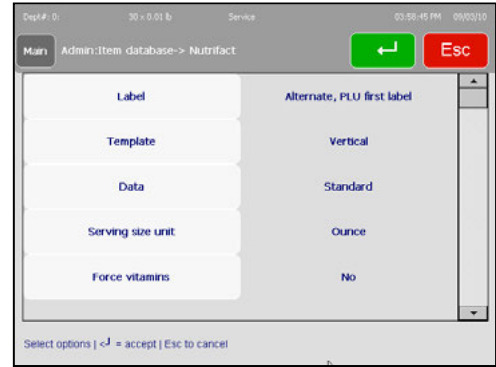

Note: Current versions of host maintenance software may not support the new meat nutrifacts formats in the NF records. Programs such as SmartX and WinDataback will be updated in the future.

\*Currently, only the Vertical, Tabular, Linear Landscape, and Linear Portrait are supported by SmartX and WinDataback.

Refer to Scale Settings/Nutrition Settings for Meat NF over-rides and formats.

These settings will currently over-ride the template selected in the NF records.



\*Vertical



\*Tabular



\*Linear Landscape



\*Linear Portrait



Simplified Vertical Wide (38 mm)



Simplified Vertical Narrow (29 mm)



Tabular Small Pkg (64 mm)



Tabular Large Pkg (64 mm)

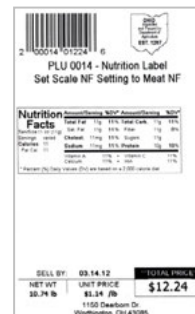

Tabular Small Pkg (56 mm)

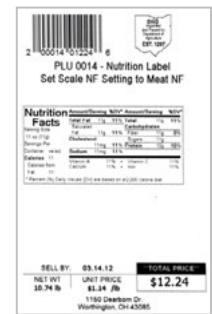

Tabular Large Pkg (56 mm)

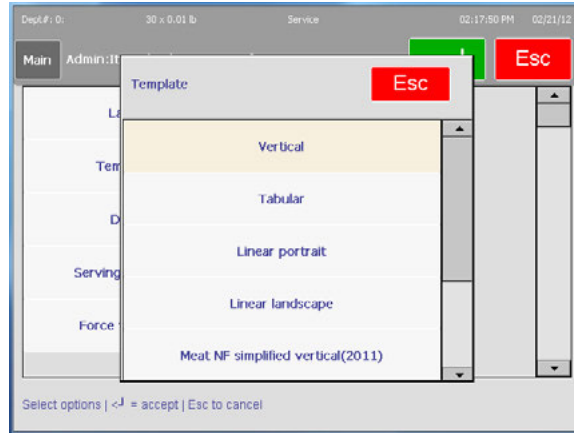

The screen will list various items such as serving size, force vitamins, Total fat (g), Total Fat (5), etc. When all selections have been completed, press the **Enter** key to save the changes.

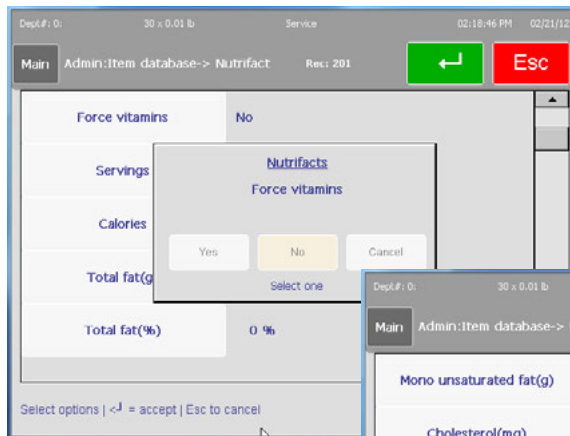

## COOL



Optional USB keyboard is recommended.

Country of Origin Labeling (COOL) is information assigned to a PLU that designates where a product came from and where it was processed. In many ways COOL records (Country of Origin Labeling) are treated very similar to ingredients records. COOL records must be assigned to a PLU in order to print. COOL implementation involves a combination of COOL Text Records, COOL Production Text Records, COOL Countries and possibly COOL Pretext.

COOL is supported through specialized Extra Text Records and lists of extra text records that are associated with the PLU record. The operator can choose a preconfigured COOL statement or, create custom COOL statements, and if enabled, enter tracking and Lot numbers.



**COOL Text**

COOL Text records contain the complete statement of how the product was harvested and where it was harvested. Common examples of a COOL Text record are "Wild Caught" or "Product of USA".

Multiple COOL Texts can be chained together to give an operator more selections. This is useful for a retailer that purchases an identical product from multiple countries. These type of lists are best created and maintained in MT SmartX or through other host software.

**Production Text**

Production text is a phrase in the list such as "Produced in", "Processed in". Production text is created the same way as COOL Text.

**Country Text**

Country text is a list of countries and the individual country names (literals). Country text and text lists are created the same as COOL Text as described above.

**Pre Text**

Pre Text is a word or phrase that prints before the COOL Text on a label. Pre Text is programmed into the PLU record and cannot be overridden by the operator. Pre text and text lists are created the same as COOL Text as described above.

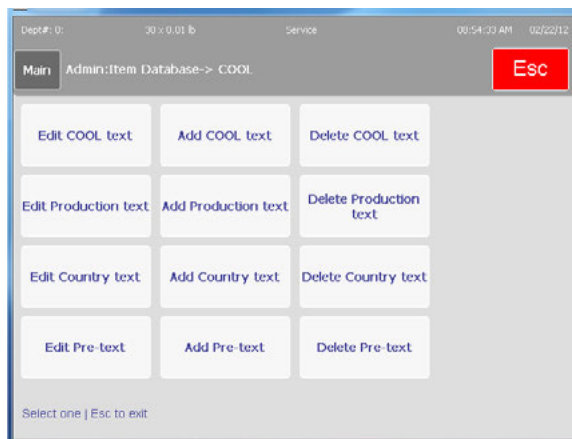

**Create/Edit COOL Text**

COOL records can be created or edited in the Admin/Item Database/COOL screen. Additionally, COOL records can be created and downloaded from a host or program such as MT SmartX. To add a COOL record, select Add or Edit.

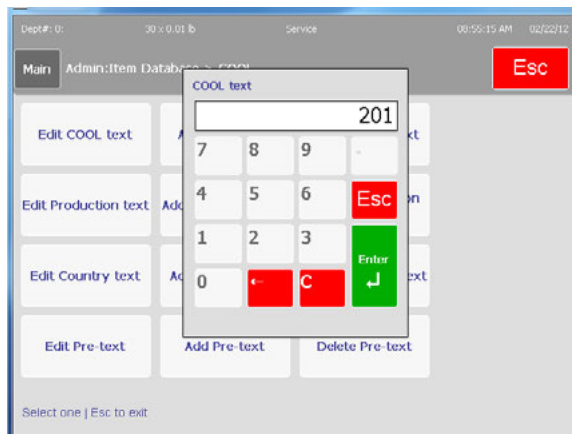

If the record does not currently exist, press Add to continue or Cancel to exit without creating the record.



Press Enter to accept the characters per line, or enter the new value (32 or 42).

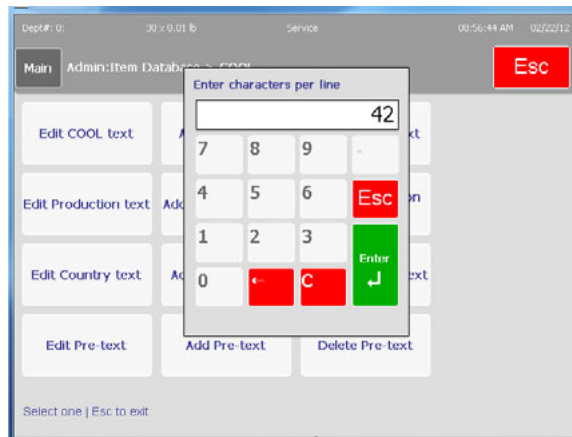

Type in the new COOL text using the on screen keyboard. For capital characters press the SFT (Shift) button.

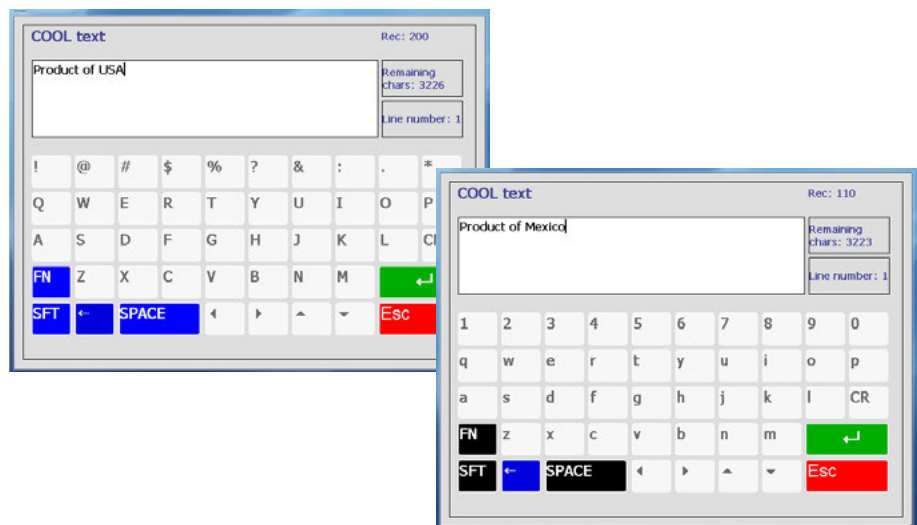

For Special Characters, press the FN button. The FN button will also display two different characters keyboards when SFT is pressed.

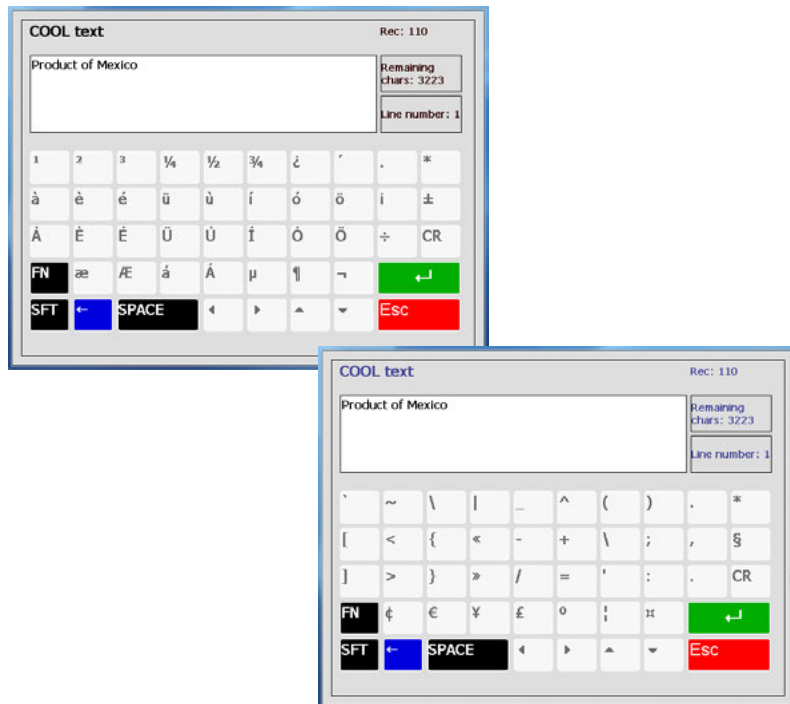

The same procedure is used to create text for the Production, Country, and Pre text files.

### Tracking or Lot Numbers

When Tracking is enabled two tracking values can be entered manually. If previous tracking numbers have been used, they will display in the "Tracking Number One" and "Tracking Number Two" fields.

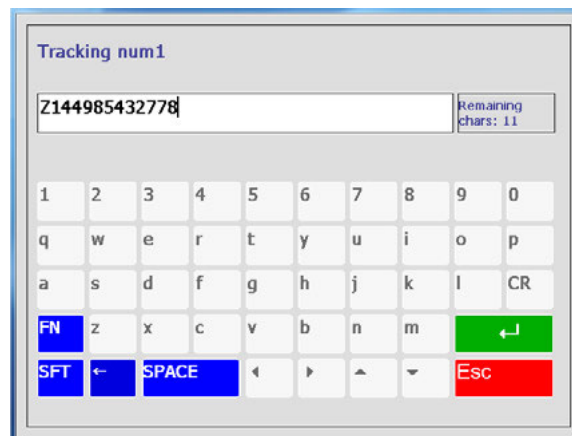

Press the green Enter button to use the displayed values or cancel to bypass the tracking number screen. To enter a number, press the Backspace/Delete button and type in the new number. Press the green Enter button to save and continue.



## COOL Records and Lists

COOL is supported through specialized Extra Text Records and Lists of extra text records created at the scale or downloaded to the scale. The Lists are then associated to the PLU record and the application allows choosing a COOL text from a menu or to create custom COOL statements.

### Chained Records

'ESC+nnnnnT' sequences can be embedded in the ASCII\_TEXT. These chained COOL Text records are then used to populate the list of available COOL Text records.

### COOL Linked Record Examples

COOL Text	Linked Record Type	Linked Record #	Data
	Note: 000001 is a Record List	05	000001
05		500005	Raised in – Canada; Harvested – Canada; Processed in – USA;
05		500006	Product of – Mexico; Processed in - USA;
05		500007	Born in - Canada; Raised in - Canada, USA; Processed in – USA;
05		500008	Harvested in – Mexico; Processed in – USA;

Note: It is also possible to reference a list number within a list.

Example: list 000001 is embedded within linked record 000002 below as element 2.

05	000002	<ESC>+500005T<ESC>+000001T<ESC>+500006T
----	--------	---

Production Text	Linked Record Type	Linked Record #	Data
	Note: 000004 is a Record List	06	000004
06		500013	Raised in
06		500014	Product of
06		500015	Born in
06		500016	Harvested in

Country Text	Linked Record Type	Linked Record #	Data
	Note: 0000025 is a Record List	07	000025
07		500032	Argentina
07		500033	Canada
07		500034	Mexico
07		500035	USA

Pre Text	Linked Record Type	Linked Record #	Data
		08	000034
08		000053	Wild

### Individual Records

Individual records will typically be individual complete COOL statements. Examples: "Born in – Mexico; Raised in – Mexico, USA, Canada; Processed in - USA".

Note: punctuation convention used:

"-" after Production step.

"," between Countries.

";" after Production/Country entries.

COOL List records are the list of relevant COOL text for a specific PLU. The exception to this rule is the COOL Pre-Text; since it is a single text record the actual text record number is associated to the PLU record.

The COOL text records and the COOL Lists of text records are separated by record number ranges. Text Records have a record number assigned to them in the range of 0-500000. Lists of text records have a record number assigned to them in the range of 500001-999999.

The identifiers used for COOL linked record lists must be in the 0-499999 range. The 500000-999999 range is reserved for the COOL text literals used to populate each list element. The type 8 record is used for the Pre-Text Portion of the COOL statement and points to a text literal.

COOL statements are a composite of the Pre-Text and User Selected COOL records. They are limited to 150 Characters.

The COOL system works by using Extra Text type 5, 6, and 7 links in the PLU record as the ID of the selection list to be displayed on the scale. COOL Extra text records are as follows:

- ET Type 5 - Records are preconfigured COOL declarations and lists of preconfigured records.
- ET Type 6 - Records are keywords or production steps and lists of keywords used when building custom COOL declarations. For example: "Raised In", "Product of", or "Processed In".
- ET Type 7 - Records are countries and country lists also used when building custom COOL declarations. For example: "U.S.A.", "China", "Chile", or "Mexico".
- ET Type 8 - Records are the COOL Pre-text Records that are described below. However, there are no pre-text record lists. Only a single pre-text record can be associated to the PLU.

### COOL Text

COOL Text Records (link record type 5) are Country of Origin Labeling statements that are created either by the operator or downloaded from host and linked to one or more PLU's. COOL Text records contain the complete statement of where and how the product was harvested.

Common examples of a COOL Text record are "Wild Caught" or "Product of USA".

Multiple COOL Texts can be chained together to give an operator more selections. This is useful for a retailer that purchases an identical product from multiple countries.

In order to provide a chained COOL Text record, a list of COOL Text Records must be created and assigned to PLU so that when the operator calls the PLU, a list of options is presented on the scale display. COOL Text Records are chained together using [ESC]+ to form a list.

### COOL Production Text

COOL Production Step (Link Record Type 6) - This record type is used by the operator to select the Production Text and to build a custom COOL Text record, if there isn't a default record.

Examples of Production Step are: Wild Caught, Farm Raised, Product Of, Born In, Raised In, Processed In, Harvested In and Imported From.

Multiple COOL Production Texts can be chained together to give an operator more selections. Product Text Records number must be above 500,000 and Production Text List number must be less than 499,999.

### COOL Country Text

COOL Country Text (Link Record Type 7) – This record type is used by the operator to select the countries and build a custom COOL Text record if there isn't a default one.

Examples of Country Text are: Argentina, Australia, Bahamas, Bangladesh, and Belize.

Multiple COOL Country Texts can be chained together to give an operator more selections. Product Text Literals number must be above 500,000 and Product Text List number must be less than 499,999.

### COOL Pre Text

COOL Pre text (Link Record Type 8) – This record type will be used by the operator to select the Pretext type and build a custom COOL Text record if there isn't a default COOL Text record.

This record type is rarely used because the same content that it was designed for can be used in COOL Production Step.

Examples of Pretext are: Wild Caught and Farm Raised.

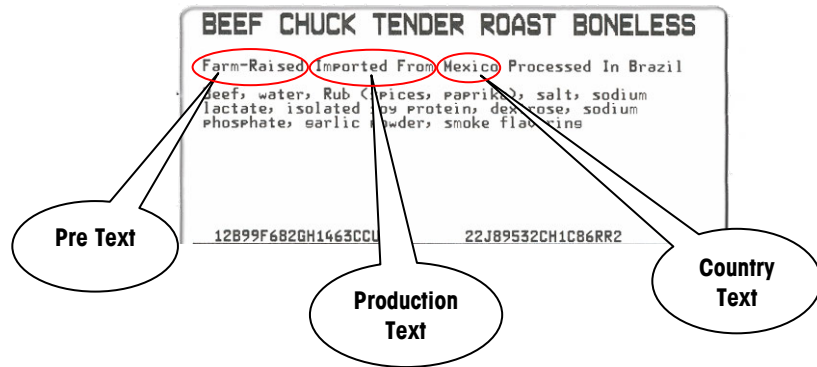

### Editing COOL Text

COOL Text can be edited on the scale or from a host program such as SmartX or WinDataback. An external keyboard and a mouse is recommended when editing the text at the scale.

### Client Mode COOL Text

From the Admin screen, press the Item "Item Database" button. Enter the master password when prompted. When the Master Edit screen appears, press the Edit button. Press the COOL Text line and then Down to display page 2 of the PLU record.



Optional USB keyboard is recommended.

The screenshots illustrate the following steps:

- From the Admin screen, press the Item "Item Database" button. Enter the master password when prompted. When the Master Edit screen appears, press the Edit button. Press the COOL Text line and then Down to display page 2 of the PLU record.
- From the Admin screen, press the Item "Item Database" button. Enter the master password when prompted. When the Master Edit screen appears, press the Edit button. Press the COOL Text line and then Down to display page 2 of the PLU record.
- From the Admin screen, press the Item "Item Database" button. Enter the master password when prompted. When the Master Edit screen appears, press the Edit button. Press the COOL Text line and then Down to display page 2 of the PLU record.
- From the Admin screen, press the Item "Item Database" button. Enter the master password when prompted. When the Master Edit screen appears, press the Edit button. Press the COOL Text line and then Down to display page 2 of the PLU record.

### Impact M – REM Master Editor

Press the COOL Text line, and enter the number of the record to edit.

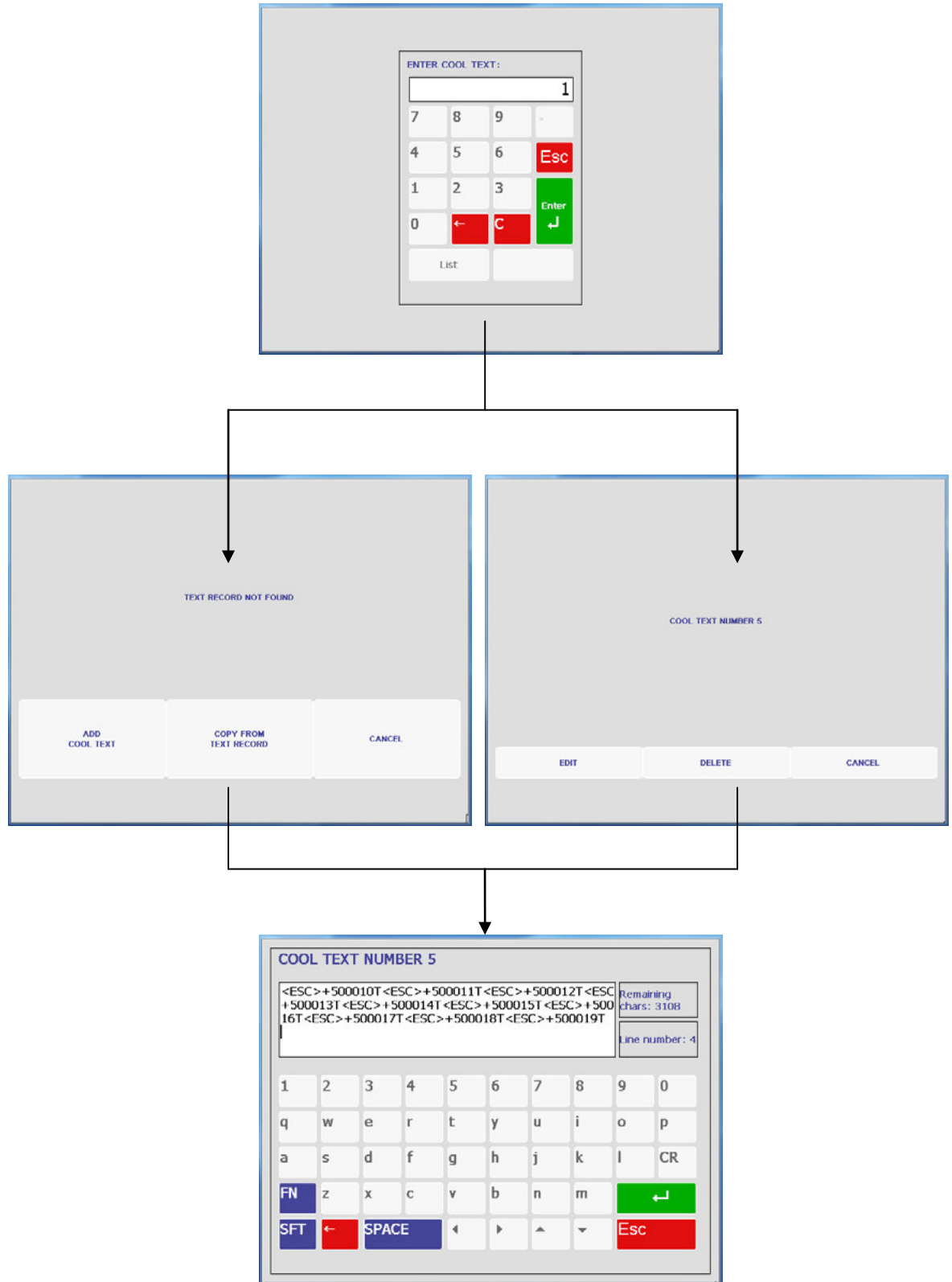

Impact M – REM Master Editor

**Standalone Mode COOL Text**

From the Admin screen, press the Item "Item Database" button. Enter the password if prompted, and then press the COOL button. Select the "Edit COOL Text" or the "Add COOL Text" buttons.

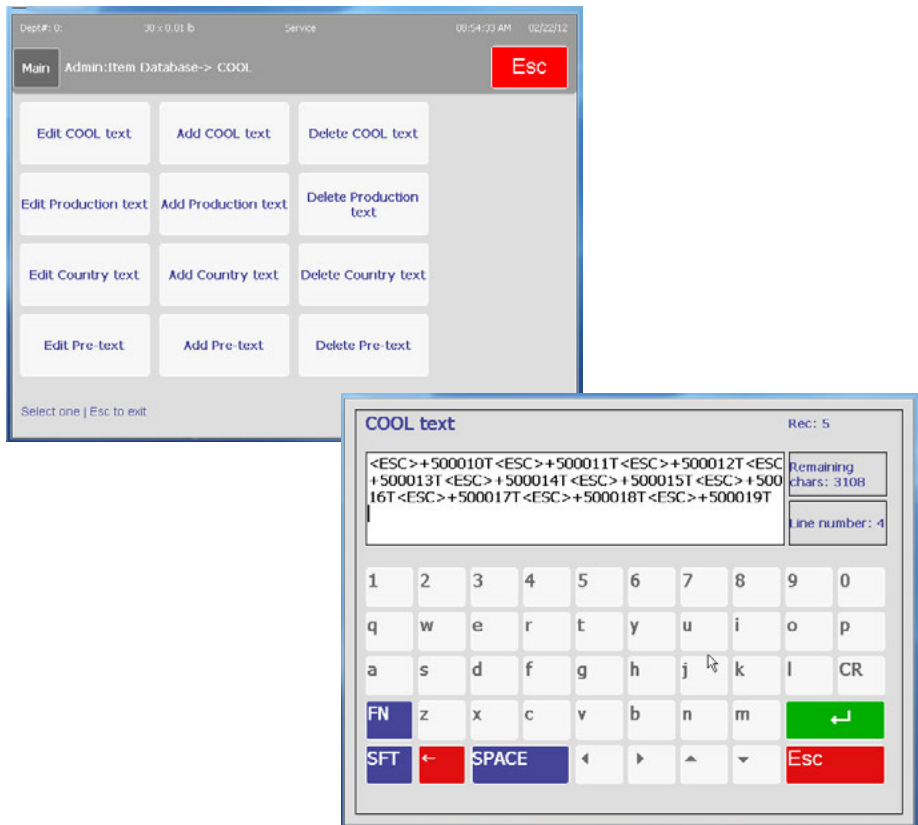

**SmartX/WinDataback COOL Text**

To create or modify COOL Text use the COOL editor in WinDataback or the COOL and COOL List Editor in SmartX.

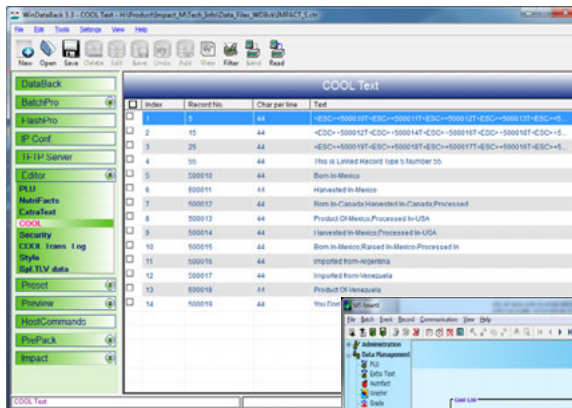

WinDataback 5.3

SmartX 5.x

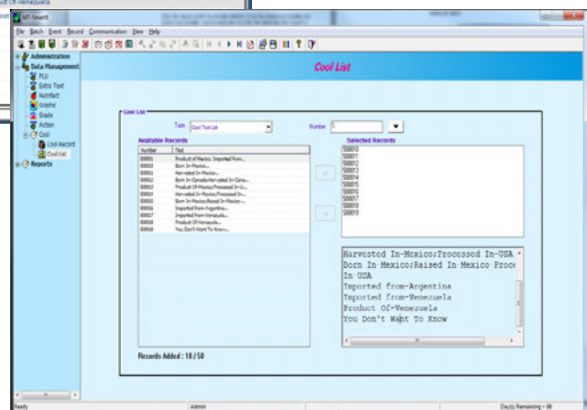

## COOL Setup

To enable COOL features, open the Admin/Unit Setup/Scale Settings/COOL Setup screen.

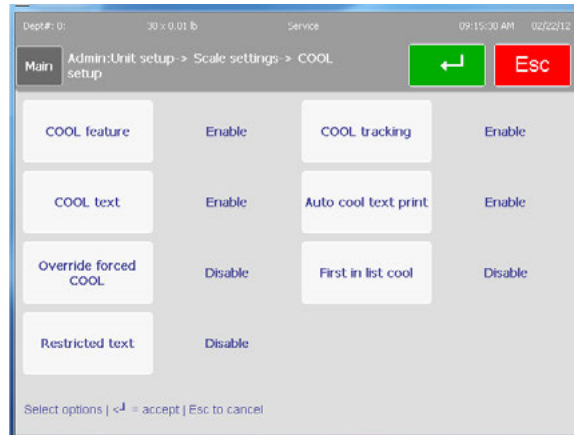

### COOL Feature

This enables or disables the COOL function.

### COOL Text

Enable allows an override from the PLU screen. Disable displays data, but touch box is not active for overrides.

### Override Forced COOL

Enable allows Forced COOL to be canceled or overridden by the operator. Disable prevents overrides and the “No COOL” key will not be displayed.

### Restricted Text

This setting governs the way the COOL screens are presented and how it operates.

**Disable** - When set to Disable and Force COOL = YES in the PLU record, the operator is required to manually select a COOL text and press the ENTER key to accept. Optionally, if OVERRIDE FORCED COOL is set to Enable, the default COOL text can be changed by selecting another COOL text or by selecting a Custom COOL text. The setting in the PLU record Force COOL must be set to YES for this feature to work. Maximum length of text is limited to 150 characters.

**Enable** - When set to Enable, the last used COOL text is automatically highlighted and if no change is required, the ENTER key will accept the displayed COOL text. Optionally, if OVERRIDE FORCED COOL is set to Enable, the default COOL text can be changed by selecting another COOL text or by selecting a Custom COOL text.

Some other notes when using Restrict COOL Text Mode:

- Operator must always make a selection of COOL Text.
- If changing the default text, the operator will be presented with a message verifying the choice.
- Last selection on Custom COOL must be a country.
- Text wrapping shows up different on the screen.
- Maximum length of text is limited to 110 characters.
- Date format changes.

### COOL Tracking

The tracking feature can be used to enter an additional number or code to a specific product or vendor.

### Auto COOL Text Print

When this is set to Enable, the default COOL statement is printed without operator input. The operator has the option of overriding the default manually.

### First in List COOL

When this is set to Enable, the default COOL statement is the MRU (Most Recently Used). When the MRU is blank, the first-in-list is the default. When set to Disable, the first-in-list is the default. This is used only when the Auto COOL Text Print is set to Enable.

### Label Formats

In order for COOL to print on the label, the label format in use must have the COOL field configured in the format. Shown below are the field selection screen, the Field Edit screen for the COOL Text, and an example label with the COOL field configured.





## Using COOL

In order for COOL to function, the following conditions must be met:

- COOL records must be created in the database.
- PLU records must be updated with the COOL numbers.
- COOL must be enabled in the scale setup.
- COOL Field must be configured on the label style.
- The COOL list must be created before the menu selection will work. SmartX or WinDataback will work for the list creation.

If the PLU has a COOL record already assigned, it will show on the PLU screen as shown below.

The screenshot shows a PLU screen for 'LEAN GROUND BEEF 80% Lean'. At the top, there are fields for 'Gross Weight (lb)' (0.00), 'Tare (lb)' (0.00), 'Unit price (\$ / lb)' (1.99), and 'Total price (\$)'. Below this, the PLU number '1' is shown. The main area contains several fields: 'Extra text 0:', 'Nutrifact 201', 'Pack date 02/23/12', 'COOL Born In Canada', 'Shelf life 02/23/12', 'Accumulator Auto', 'Use-by date 02/23/12', 'Label style CONT BY WT 2 DATE IM', 'Graphics 0', 'Mode Service', and 'Grade'. On the right side, there are buttons for 'More overrides', 'Blank fields', 'Esc', 'BATCH', 'Memory', and a green 'Enter' button.

If COOL is forced, the operator will be required to choose and verify the COOL record. The MRU (Most Recently Used) will display at the top and can be selected by pressing the box. To select a different COOL record, press one of the other selections listed. Press the green Enter button when finished to continue.

The screenshot shows a COOL selection screen. At the top, there are buttons for 'Main', 'PLU: 1 LEAN GROUND BEEF', a green 'Enter' button, and a red 'Esc' button. Below this, there is a list of COOL records. The first record, 'MRU:Born In Canada Harvested In Canada', is highlighted with a white box and an arrow pointing to it. Below it are 'Born In-Mexico', 'Harvested In-Mexico', and 'Born In-Canada;Harvested In-Canada;Processed In-USA'. At the bottom, there are buttons for 'Custom' and 'No COOL'. A footer message reads 'Select one | < = accept | Esc to cancel'.

## Accumulators

The **Accumulator** array allows the user to view and modify the accumulator settings.

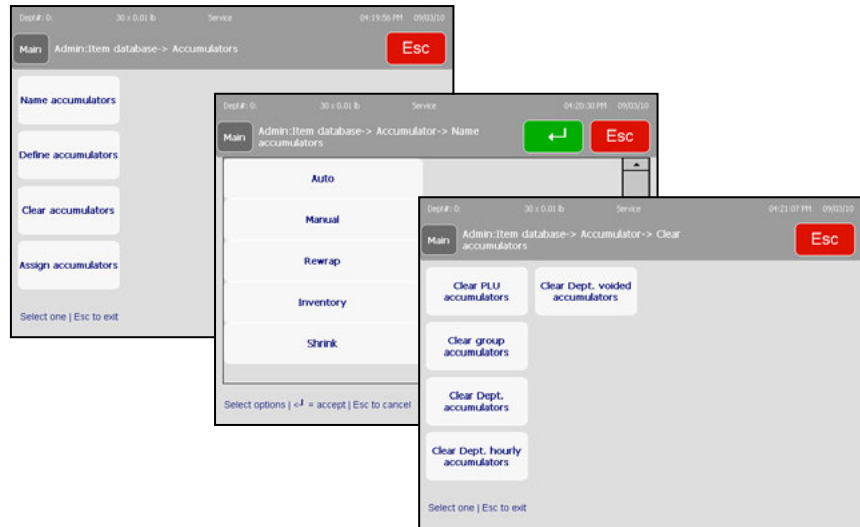

**Name Accumulator** – this function allows you to rename the existing accumulators or add new ones to the existing list. Select the accumulator you would like to rename by touching the screen with the tip of your finger. Press **Enter** when satisfied with your changes.

**Define Accumulator** –enable or disable existing accumulators. Pressing the individual fields toggles the accumulators between yes and no. Set as necessary and press **Enter** when finished.

**Clear Accumulator** – used for clearing totals accumulators. Follow the menu prompts to make changes in the areas below.

- Clear PLU accumulators
- Clear group accumulators
- Clear department accumulators
- Clear department hourly accumulators
- Clear department voided accumulators

---

## Reports

Pressing the **Reports** button at the **Database** screen will bring up the Reports screen. Press the corresponding button to select the report and follow the menus (Department, hours, date, etc.).

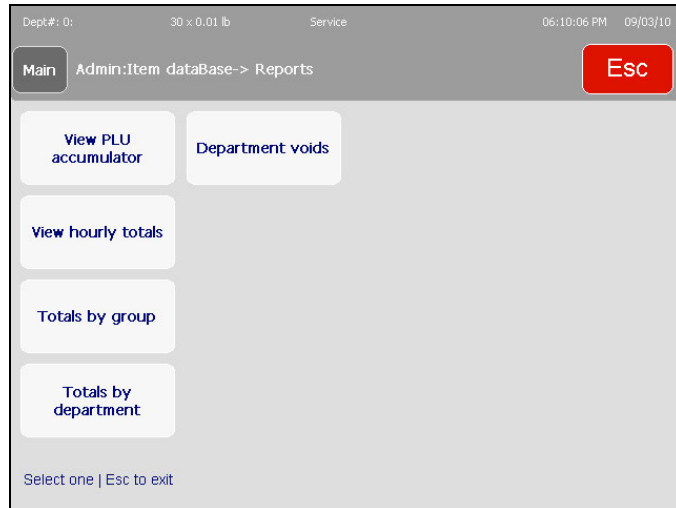

**View PLU accumulator** – brings up the accumulator data for a particular PLU.

**View hourly totals** – view the total transaction records for a particular span of time.

**Totals by group** – allows the user to view the weight and value (among other categories) totals for all PLUs in a particular group. Key in the group number and wait for the unit to scan.

**Totals by department** – Same as **Totals by group** but with all the PLUs in a particular department. Key in the department number and wait for the unit to scan.

**Department voids** – enables a report to be viewed containing the weight totals, value totals and modified value totals (among others) of anything that has been voided out on the unit.

---

## Clear

The **Clear** menu allows for deletion of data. Touch to select the category to clear and follow the menu prompts to eliminate data.

To delete only select PLUs or bits of data, you will be prompted for a number. When complete, you may press **ESC** to return to the **Database** main screen.

## Action Code

The **Action Code Text** menu allows for three different functions by selecting the type.

- 1.) Create or edit a message to the operator via the operator screen
- 2.) Change the store address line on the printed label
- 3.) Implement specific marquee action code (taken from the image database)

Insert the associated number when the pop-up appears and edit as normal.

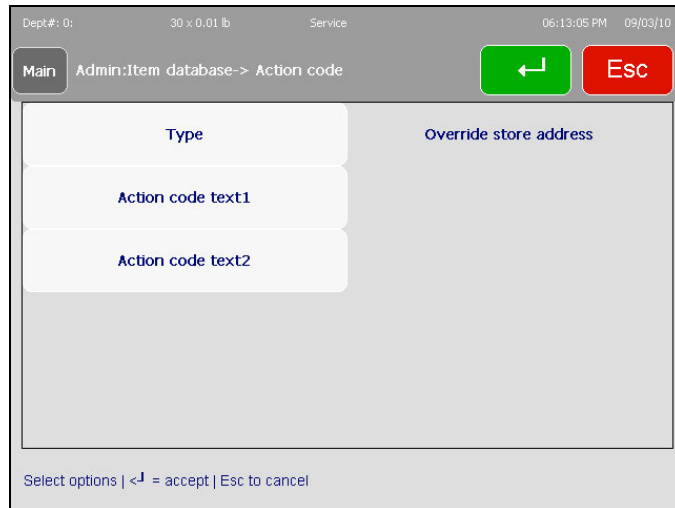

Press **Enter** when finished making changes.

# Grade

The **Grade** function allows for editing numerical grade entries in the embedded database. Enter the grade number and then choose whether to change (edit) or delete (clear) that grade entry (below screenshot).

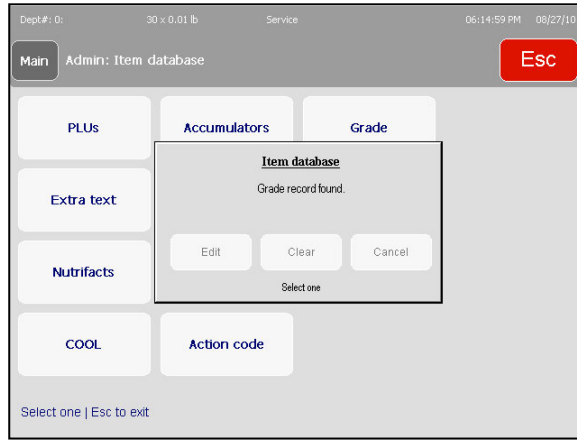

The **Edit** command will display a keyboard screen where you may enter a string of text defining the grade selection. The **Grade** definition is limited to 23 characters. Press **Enter** when finished.

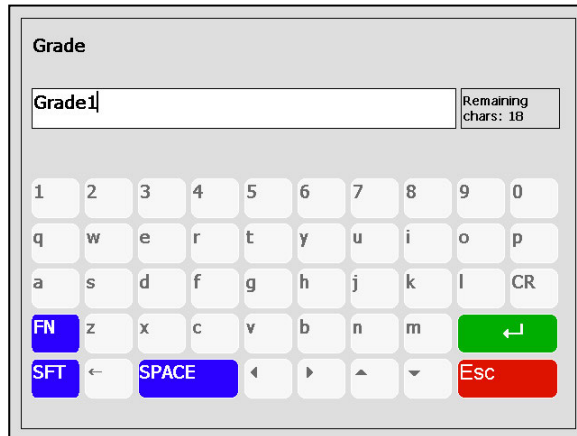

## Group

The **Group** function is used to create or modify groups (assigned during PLU entry creation or modification). If a record is not found, you will be prompted to add a new record or cancel. If the record exists, you can select Edit, Delete, or Cancel.

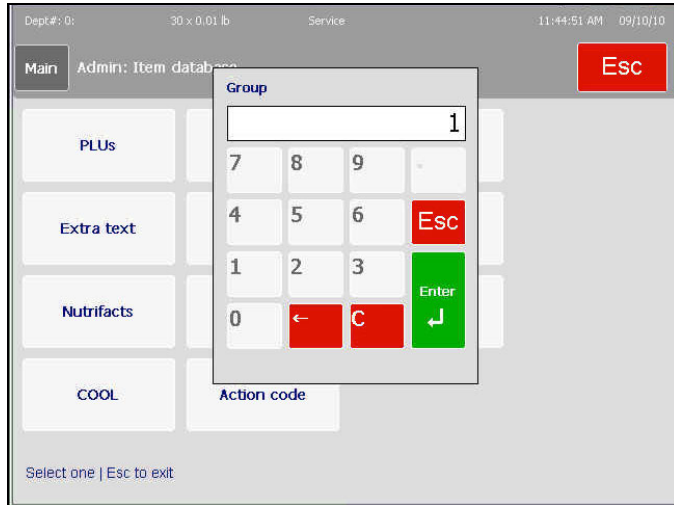

Selecting Add or Edit will open the keyboard for editing. Press **Enter** to save your changes. There is a 12-character limit in the grade fields.

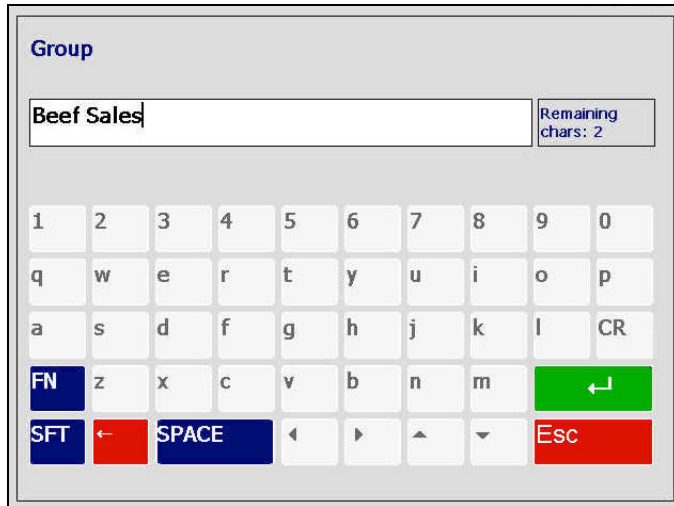

## Department Settings

Department Settings is used to enter or modify items that will print on the label such as Department Name, Store Name and Address, and default UPC number.

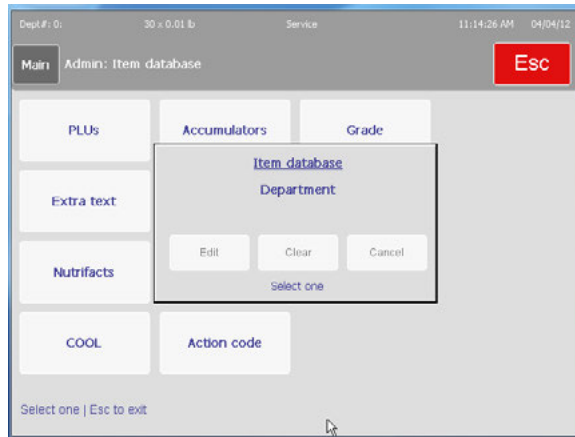

**Edit** – Modify department data.

**Clear** – Clear the data in the Department Settings screen only.

**Cancel** – Return to Item Database Screen

### Edit

To add or modify department data, press the Department Settings button and then the Edit button.

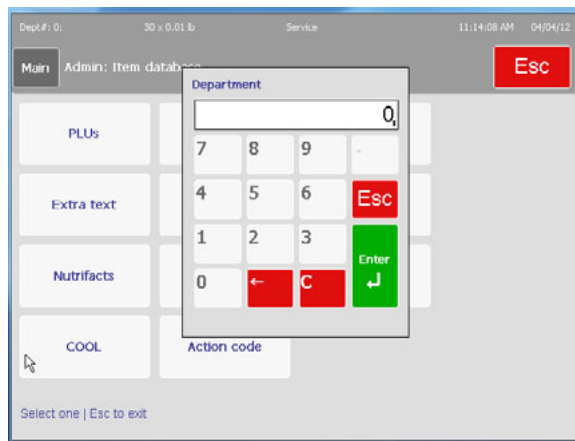

Existing department data will display. If none was previously entered the fields will be blank. Press any of the buttons to enter new data.



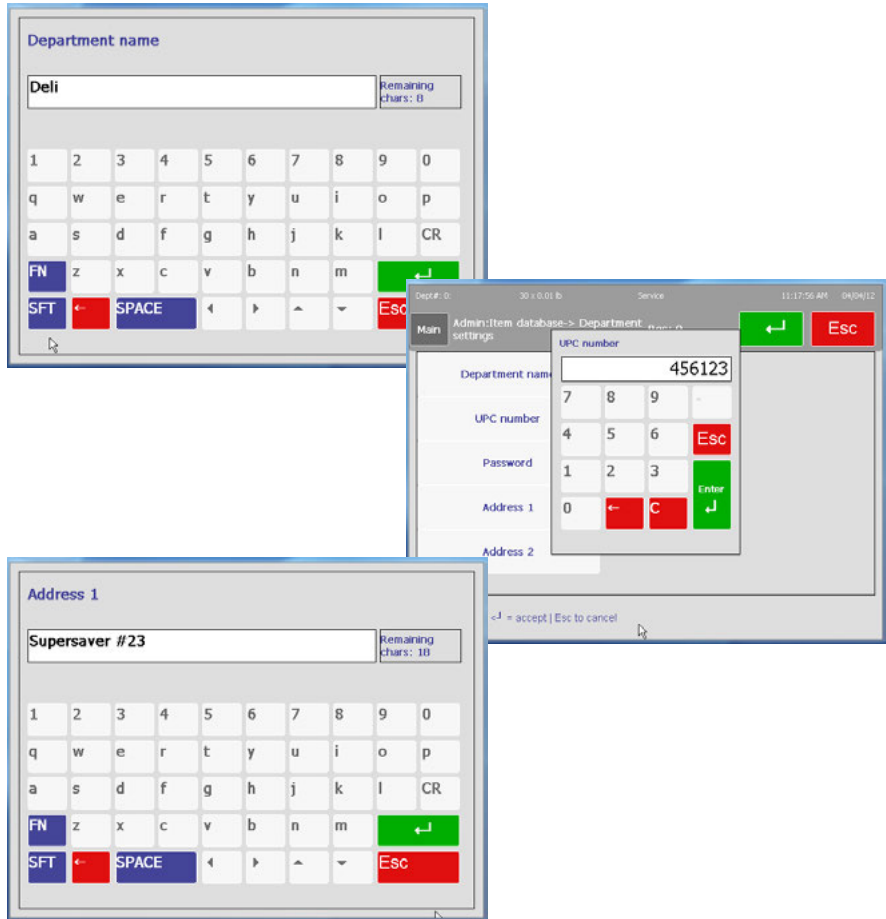

### Clear

Clear is used to clear the department data (name, UPC, address). This will not affect any PLU or totals data.





## Presets

The Preset menu is used to create or modify the Preset keyboard layout. The menu allows many customizations from creating preset pages to defining groups of PLUs.

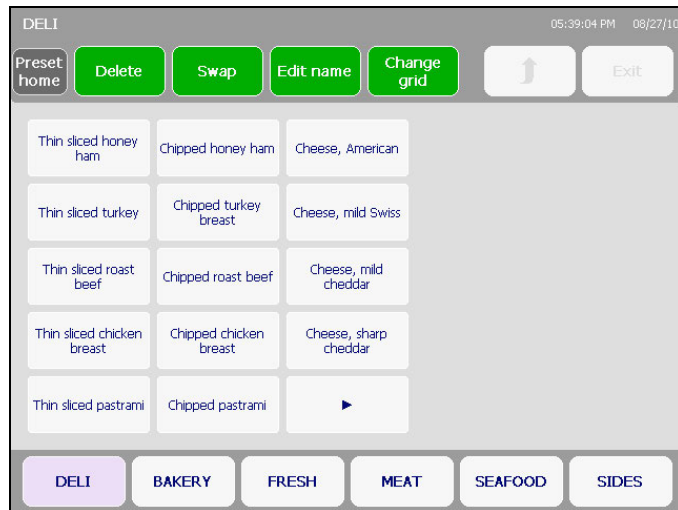

Included in this screen are the following buttons –

**Edit Name** – modify a preset page or individual PLU's name

**Swap** – used to swap positions of pages/PLUs from other preset pages/PLUs

**Delete** – permanently remove a preset page or PLU preset from the database

**Change Grid** – alter the layout of the preset buttons/pages in the grid

To use these functions, you must first press the function button and then touch the preset to modify. For example, to change a PLU page/item name, first press **Edit Name** before pressing any of the keys.

When one of the green keys is pressed, it will become darker green, signifying that it is active.

---

## Delete

Press this button and then select the PLU or preset to be deleted. A window will pop-up verifying you want to delete this preset. Be certain, as you cannot retrieve the PLU or preset after deletion.

---

## Swap Pages

You can swap pages of preset information back and forth between the established presets. Begin by pressing the **Swap** key and pressing the first preset you would like to move. Press the swap key again, followed by the second preset key (where the first will go). The swap is complete.

## Edit Name

Pressing the **Edit name** button and touching a preset button will bring up the following screen (the text will likely be different) –

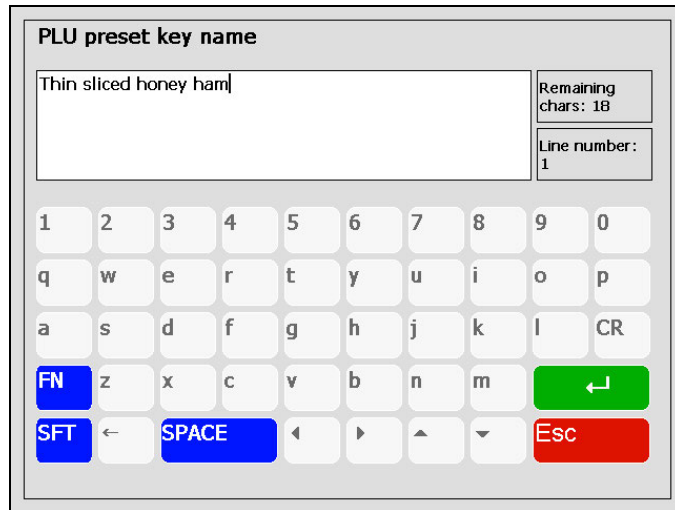

Type in a new name for the preset and press **ENTER** to save changes.

## Change Grid

This command allows the user to format the grid to a different configuration stored within the preset database. Three PLUs across by Five PLUs down is the standard (and suggested) configuration for the Impact M scale.

## Programming Presets

From the main Preset screen, you can create any number of new preset pages and populate them with PLUs. To begin, press any blank key.

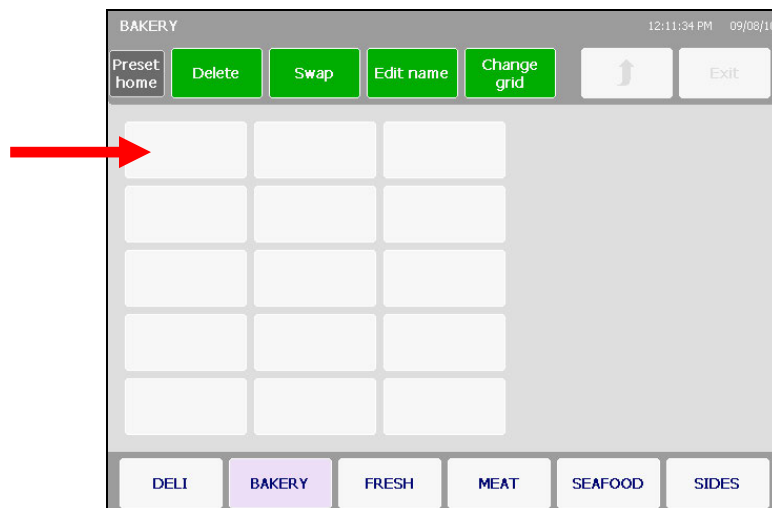

Select a department number and enter a PLU number on the keypad that pops up upon touching a blank key.

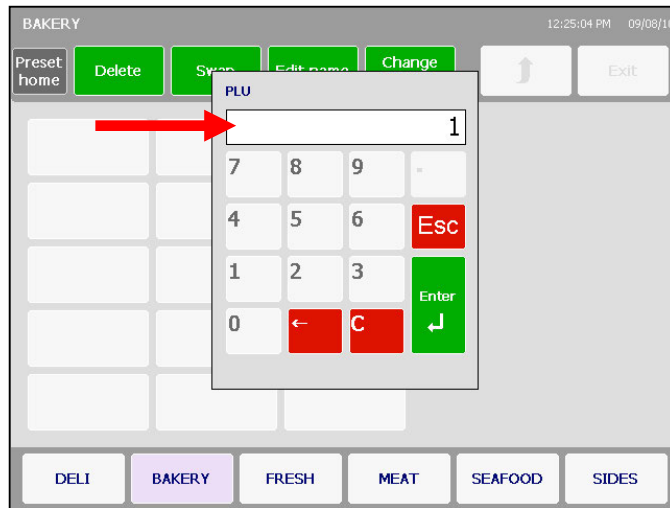

The keyboard screen will display where you can enter the description. Press the enter button to save your changes.

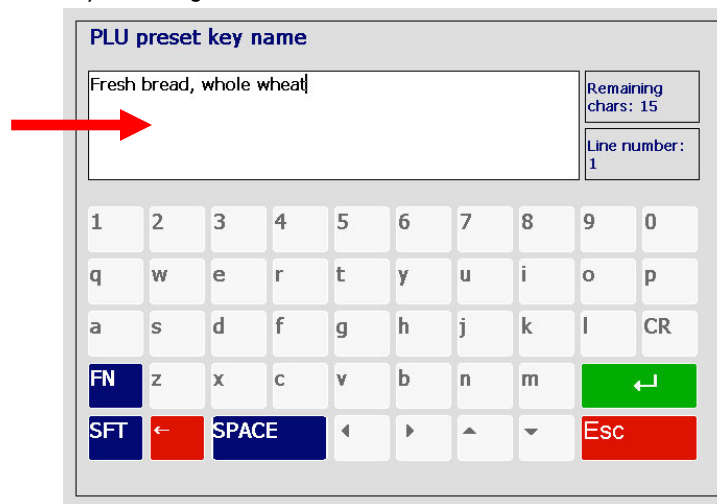

You will be prompted to select a graphic from a list of those available. If applicable, choose a graphic. If not, only text will display on the preset button.

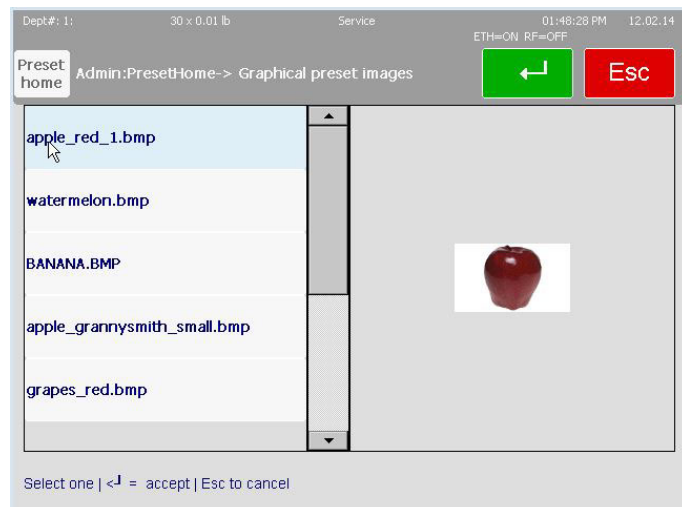

The new key should then appear on the page. Repeat this to populate the Preset page until satisfied.

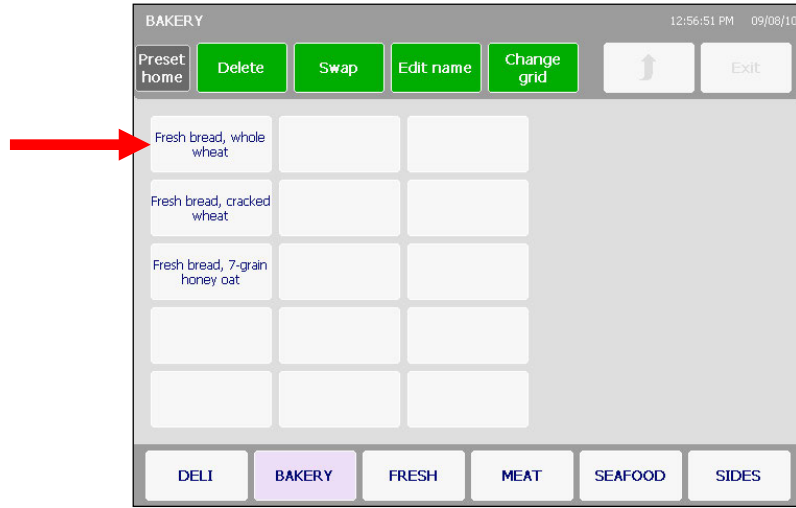

Example of a preset page with graphical presets:

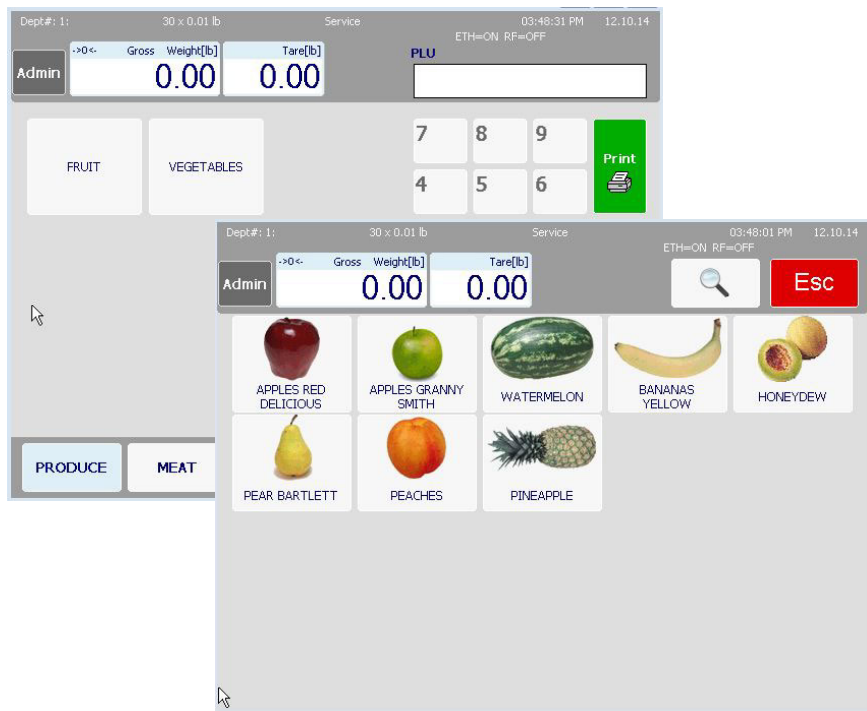

## Labels

The **Labels** menu allows a user to configure standard or custom label formats/styles.

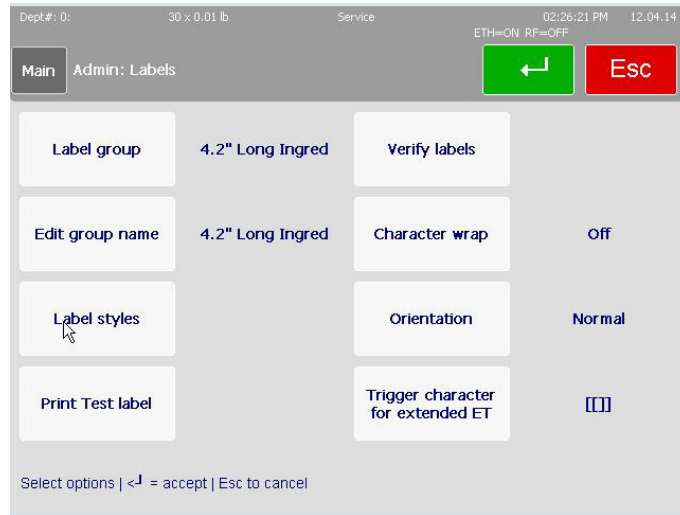

**Label group** –takes you to an array of keys representing available label sizes

**Edit group name** – allows the user to name specific groups of labels for the purpose of easier recall at later dates

**Label styles** – function that maps label format to PLU record label style number

**Print Test label** – prints a label of the selected label format

**Verify labels** – prints a sequence of labels representing a series of PLUs in the database

**Character wrap** – toggle on or off

**Orientation** – Printer setup (inverted or normal).

**Trigger character for extended ET** – The trigger character for extended extra text allows users to indicate a series of characters that, when found in an extra text record, would trigger a break in label to the next label. For example, could be used to separate cake ingredients from icing ingredients onto two different labels.

## Label Styles

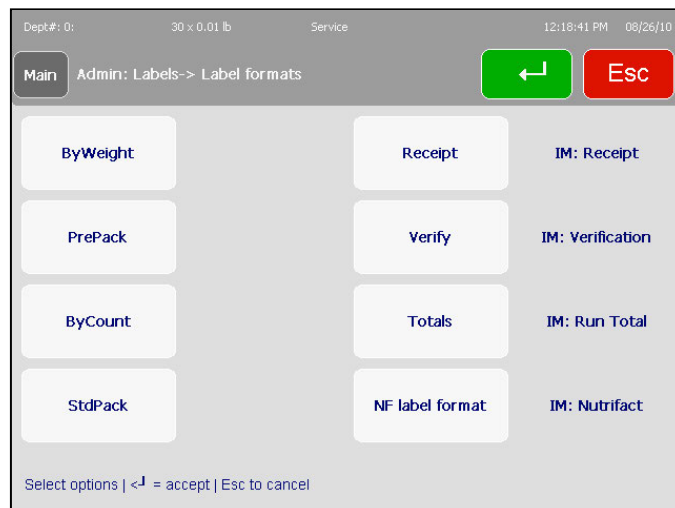

This screen deals specifically with the label parameters. You may need to use the scroll bar to see all of the options.

**ByWeight** – select to assign label styles for By-Weight transactions

**PrePack** – select to assign label styles for PrePack transactions

**ByCount** – select to assign label styles for By-Count transactions

**StdPack** – select to assign label styles for Standard Pack transactions

**Receipt** – select to assign label styles and specific formatting to the printing of receipts

**Verify** – select label format to apply to **Verify Label** printings

**Totals** – select label format to apply to **Totals Labels**

**NF Label Format** – select label format to apply to **Nutrifact Labels** (done at NF programming)

---

## **Print Test Label**

This menu is used to view labels as they are printed on label stock. This function can be used to verify exactly how the labels will look on different label stock sizes.

Select the label stock measurement of the current roll and press Enter.

---

## **Verify Labels**

To use the **Verify Labels** menu, you can enter a range of PLUs or select a department (with the third field) before pressing the **Begin Printing** button. Once this process begins, it can be stopped by pressing the **ESC** key on the keypad.

## Unit Setup

Pressing the **Unit Setup** opens the following screen.

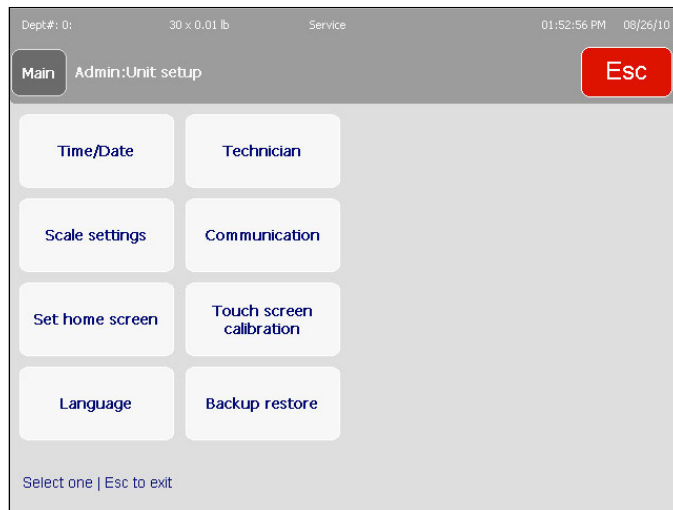

This screen includes following functions described in detail in this section.

**Time/Date** –Time and date settings

**Scale Settings** – Scale configuration

**Set Home Screen** – Select the default home screen

**Language** – select the default scale language

**Technician** – Password-protected Technician menu

**Communication** – Configuration for network and wireless

**Touch Screen Calibration** – Calibrate the touchscreen

**Backup/Restore** – Select to backup or restore scale data (requires license)

## Time & Date

The **Time & Date** menu allows you to format or set the scale's date and time. Press the **Enter** key after making any changes to apply any changes.

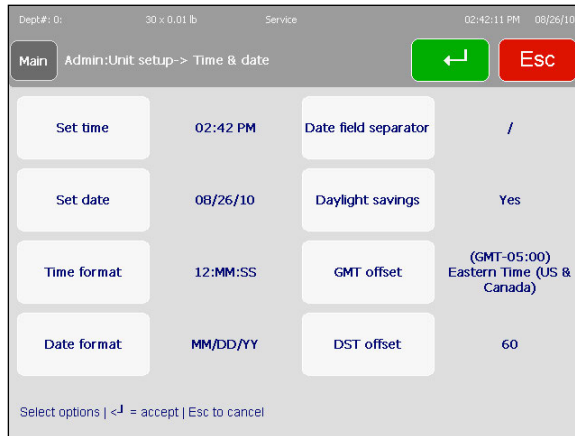

**Time/Date Format** – select to format the unit's time and date settings including time zones, seasonal daylight savings, and the time and date format (i.e. month/day/year or 11:00pm versus 23:00). DST (Daylight Savings Time) Offset is in minutes.

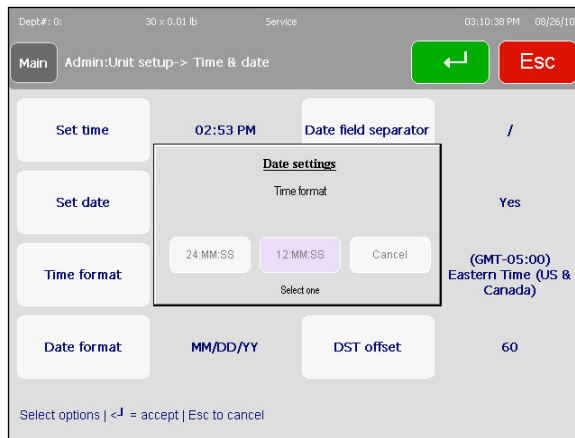

**Set Time/Date** – select to set the time and date to match your region.





## Scale Settings

The **Scale Settings** screen is used to change basic usability and functionality settings of the unit.

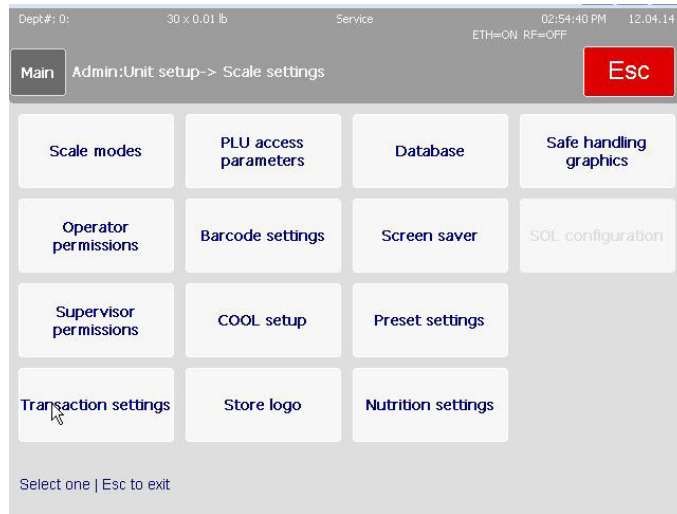

**Scale modes** – use to modify how the scale will be used, such as service, PrePack, or Self Service modes.

**Operator permissions** – set permissions for a unit operator

**Supervisor permissions** – set permissions for the unit supervisor

**Transaction settings** – choose which fields are editable in the transaction screen and other transaction screen configurations.

**PLU Access parameters** – defines how particular PLUs can be accessed

**Barcode settings** – choose the printed barcode format from a preexisting list

**COOL setup** – activate, disable or modify the country of origin labeling for the unit

**Store logo** – select a graphical logo by-number from the unit database

**Database** – select the database to use

**Screen saver** – select a series of graphic images to display as a time-out screen saver.

**Preset settings** – preset button configuration options

**Nutrition settings** – nutrition label formatting options

**Safe handling graphics** – select wide, narrow, or vertical formats for safe handling graphics.

## Scale Mode

**Scale Mode** selects how the scale will operate when calling PLUs and how it will print labels. Choose **Service**, **Prepack**, or **Self Service** modes and then set the appropriate print activities from the corresponding menus. Service clears the PLU after the transaction. Prepack retains the PLU information until clear is pressed and will automatically print a label whenever an item is placed on the platter. Self Service mode is used when placing the scale in an area where the customer will use it to weigh and print labels. In Self Service mode, access to any setup screen is limited. In order for Self Service to be selected, the scale must be set as a Category 1 scale (Unit Setup, Technician, Category) security must be enabled (Admin, Security), and one supervisor with a password must be created (Admin, Security, Users and Passwords).

Press **ENTER** when finished.

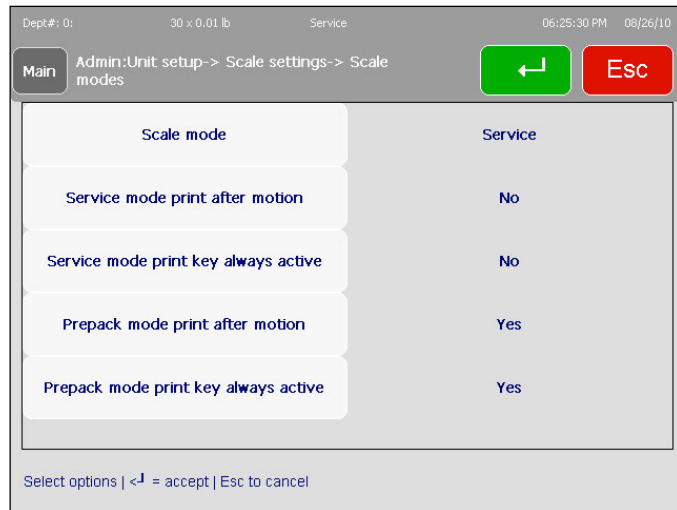

## Operator Permissions

The **Operator Permissions** menu allows items like **Memory**, different **Total** tracking, **Voids** and, formatting abilities to be enabled or disabled. Press the function to toggle the fields to the right of the function. After making the choices, press **Enter** to save the changes and exit.

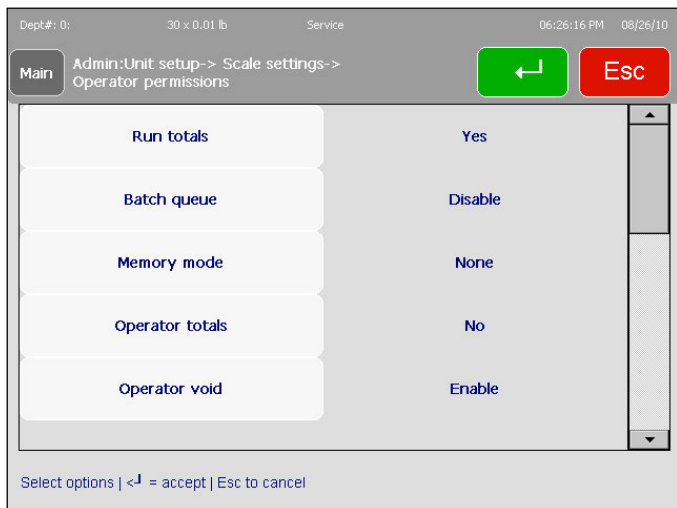

## Supervisor Permissions

Similar to the **Operator Permissions** menu, **Supervisor Permissions** allows another supervisor (normal operators are denied access to this menu) or technician to modify the fields and menus available to the unit supervisors. Toggle the choices by pressing the appropriate line and press **ENTER** to save changes.

## Transaction Settings



**Transaction Screen View** – When set to **User-Configured**, frequent shopper pricing will be displayed in the PLU transaction screen (if applicable). User-Configured transaction view also allows for customizable PLU transaction screens (using the 'Configure transaction screen' option). When set to **Classic**, frequent shopper pricing will not be displayed in the PLU transaction screen and customizable PLU transaction screens will not be enabled.

**Transaction Overrides** – Define permissions for modifying fields during the transaction process. Options include Yes (All), No (None), Operator, Supervisor or Manager.



**Program Macro** – Program macros provide the ability to create programs to run certain functions from within a PLU transaction screen. For example, a markdown macro may be configured to change the date, price and label format.

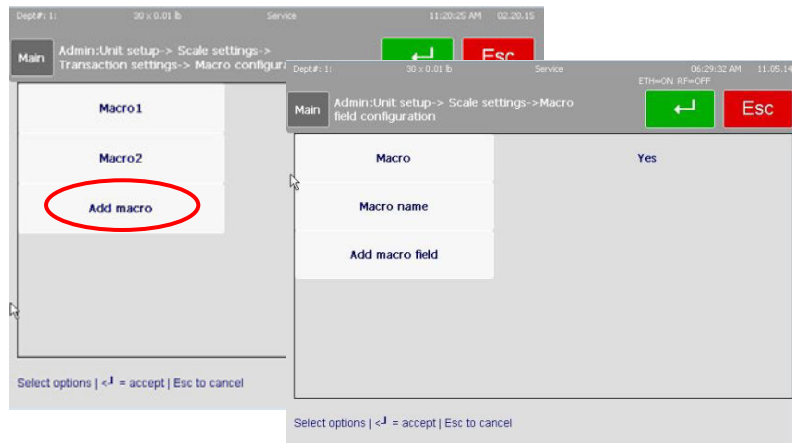

**Choose Add Macro**

Define whether Operators, Supervisors, Managers or All (Yes) have access to the **Macro**.

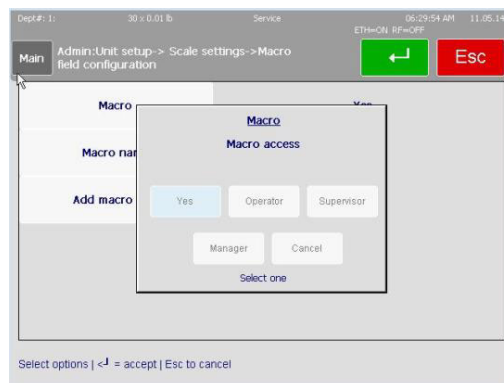

Define the **Macro Name** and **Add Macro Fields** (the steps the macro will perform such as change the pack date, discount the price, and change the label format).

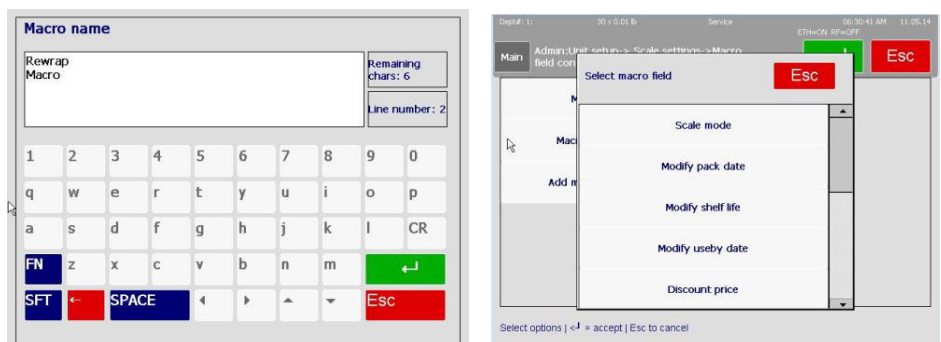

You can choose to prompt the operator for input in the transaction screen or to have automatic inputs (ex. automatically calculate a 10% discount or prompt the operator to enter the discount % during the transaction).

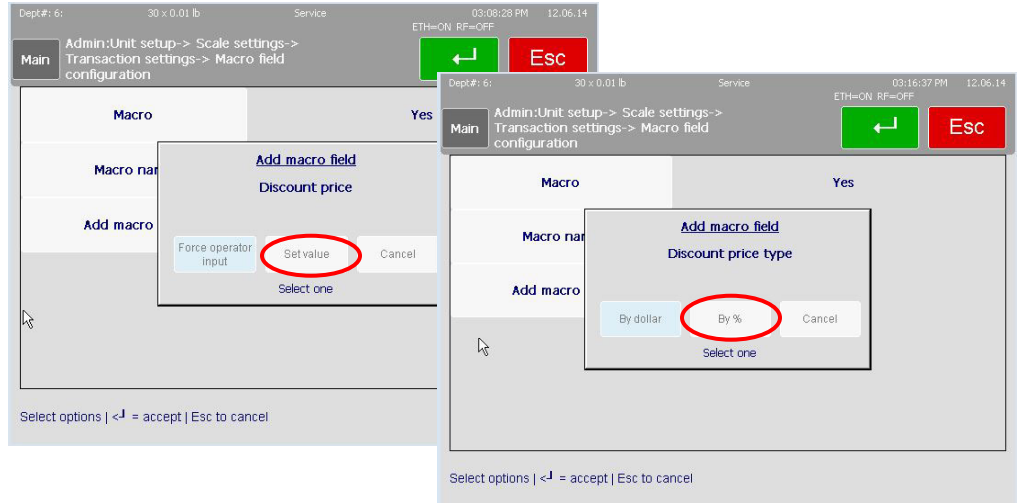

**Configure Transaction Screen** – Configure which buttons display on the transaction screen and in which order. Transaction screens are configurable by PLU type (by weight, by count, or standard pack).

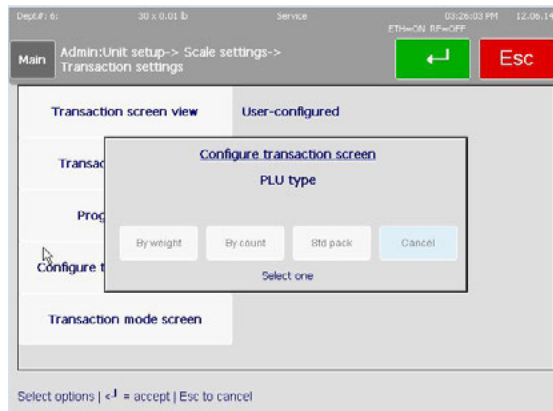

Once in the **Configure Transaction Screen** setting, a sample transaction screen will display. Select fields to change or remove. If any macros have been defined, they will appear as available buttons.

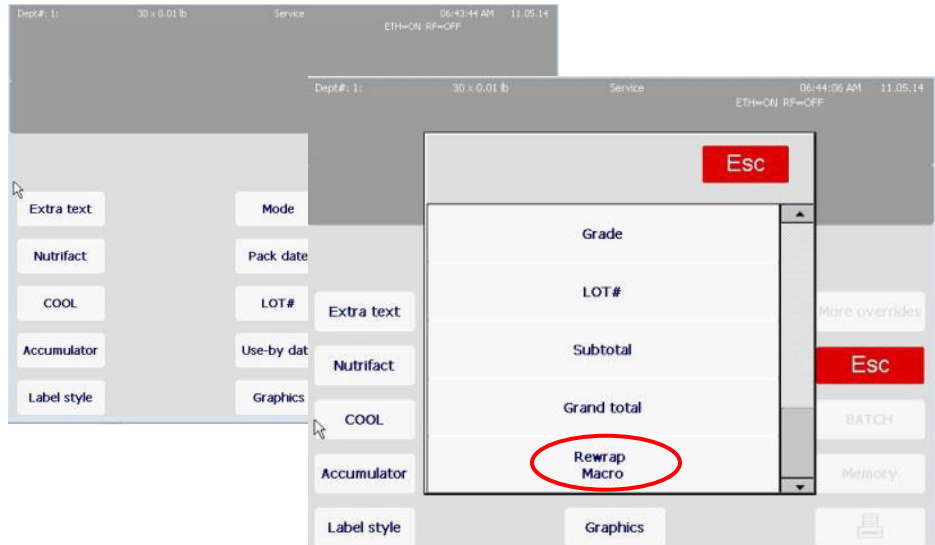

**Transaction Mode Screen** – The Transaction Mode Screen option allows users to define certain functions to be performed within a transaction mode. The transaction modes may include multiple macros. Operators can log in to a transaction mode which allows all transactions performed while logged into the selected mode to run the macros associated with that mode. For example, if you are rewrapping a batch of packages that are all expiring soon, you could log on to the Rewrap Mode, which may be configured to change the label format, pack date and unit price. Once you are done processing the rewrap batch, you would log out of the Rewrap transaction mode and begin processing transactions as normal. Operators log on to transaction modes via Operator->Transaction Mode Logon

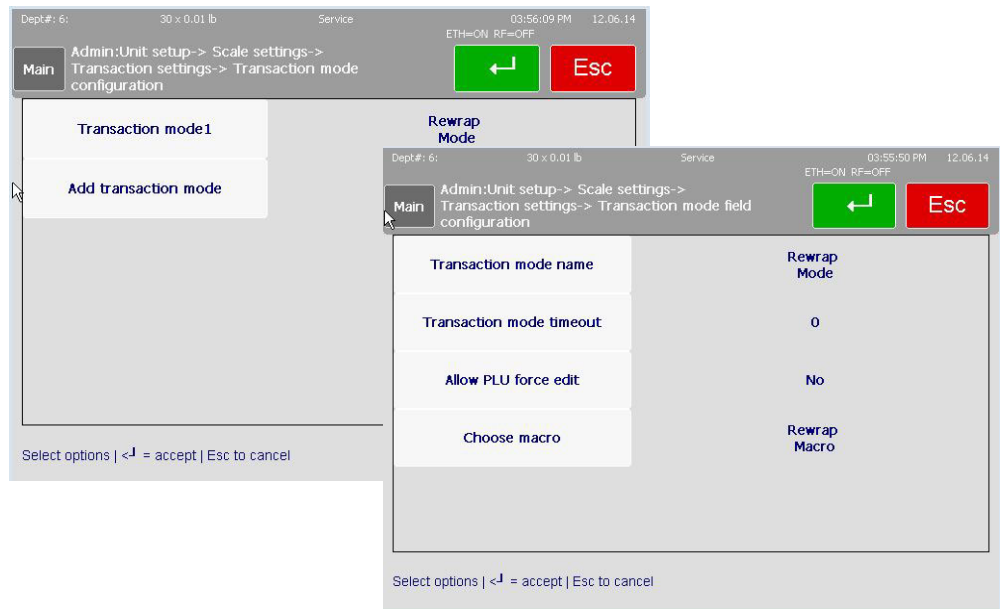

**Assign a Transaction Mode Name**

**Transaction mode (sec)** – The time in seconds of inactivity when the scale will automatically logout the operator from the transaction mode. When set to 0, there is no auto logout and Operators must manually logout (Operator/Transaction Mode Logon).

**Allow PLU force edit** – It is possible for PLU records to be downloaded from host with certain "force" flags set (i.e. force unit price, force tare 1 or 3, force PLU (manual mode), Force tare 2 or 4, force use-by date, force sell-by date). However, the scale settings could be set to not allow these in the transaction override fields, causing a conflict. "Allow PLU Force Edit" was added to resolve the conflict.

**Choose Macro** that is associated with the Transaction Mode.

## PLU Access Parameters

This menu is used to configure functions such as how the scale reacts when entering a PLU number and other transaction options. Scroll down from the first screen for all options.

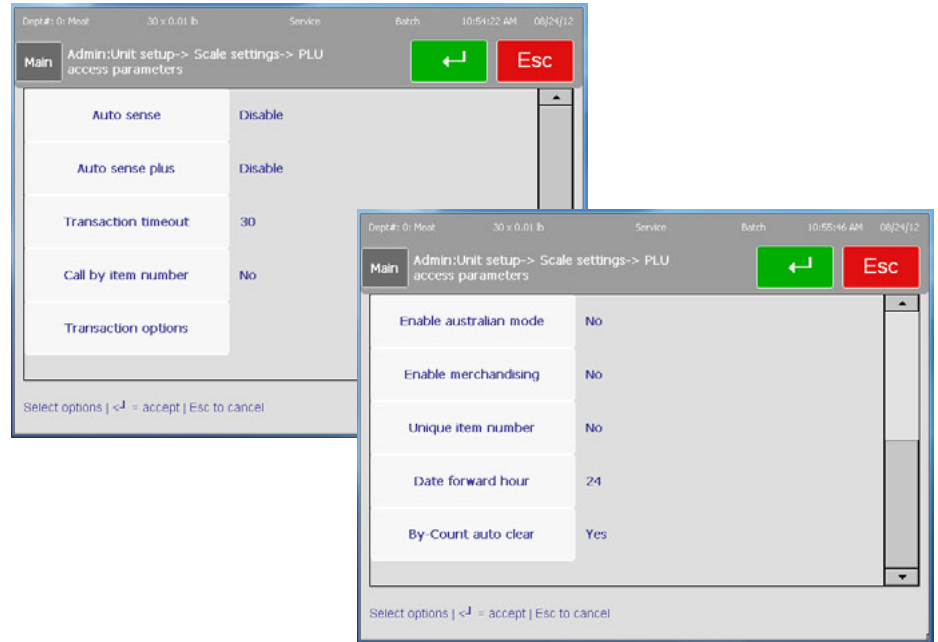

**Auto Sense** - the scale will automatically call the PLU without pressing the Enter key. For example, if the PLUs are 4-digit and Auto Sense is set to four digits, when the 4th digit is pressed, the PLU will be called without pressing Enter to complete the entry.

**Auto Sense Plus** - When Auto Sense is not disabled, the value entered is automatically ignored by Auto Sense when it is the leading digit of the PLU number entered. Example 1: If Auto Sense is disabled and 9123 is entered, PLU 9123 will be called (even if what you are trying to enter is 91234). Example 2: If Auto Sense Plus = 9, Auto Sense = 4, and 91234 is entered, PLU 1234 will be called; the 9 will be ignored.

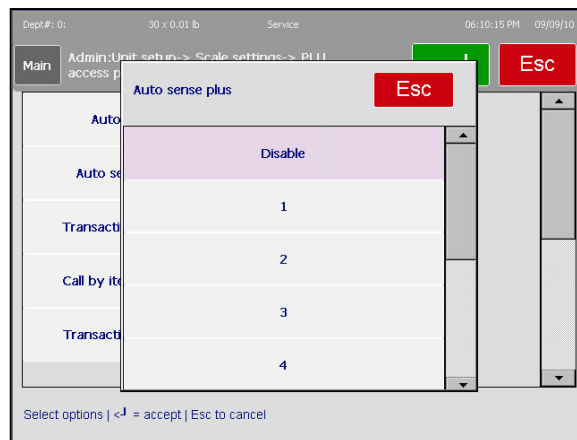

**Transaction Timeout** – The time in seconds of inactivity when the scale will return to the main menu. Select from Disable, 15, 30, 45, 60, 75, 90, 105, 120. Touch to select and then press the Enter button.

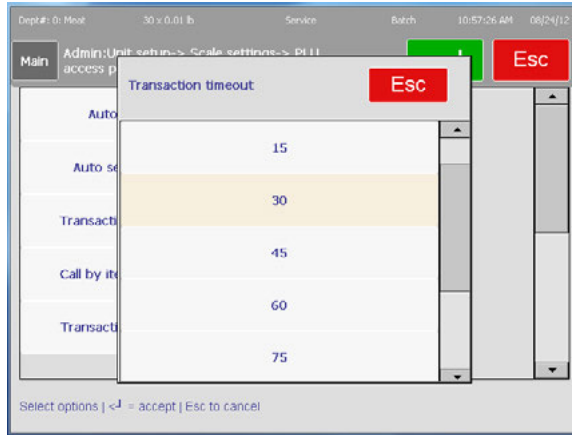

**Call by Item Number** – When this is set to Yes, item records will be called by the Item Number (UPC number). When set to No, the records will be called by PLU number.

**Transaction Options** – Configures memory mode label print individual label, future pack date, mixed net weight statements, and barcode priority.

**Memory Mode Print Individual Label**

– Yes will print a separate label for each item in memory mode. No will print a totals label for all items.

**Allow Future Pack Date** – YES allows the operator to change the pack date. NO prohibits the operator from changing the date.

**Mixed Net Weight Statement** – When set to YES, the net weight printed on the label will be in lb (kg) or kg (lb). When set to NO, the net weight printed on the label will be in oz (lb) or oz (kg).

**Barcode Priority** – Sets the priority of the bar code. When set to "PLU record, scale settings" the PLU record bar code type will over-ride the local scale settings. When set to "Scale Settings", the bar code will not be over-riden by the PLU record settings.

**Transaction blank fields** – enable or disable the 'blank fields' button in the PLU transaction screen which allows the operator to blank certain information from printing on the label.

**Operator Mode Logon** –When enabled, Operators will be required to log on to print a label (either in the PLU Transaction screen (for a single transaction) or

Operator->Operator Logon (for multiple transactions)). Transactions will also be recorded and reported on by Operator ID.

**Transaction mode timeout (sec)** – The time in seconds of inactivity when the scale will automatically log the Operator out. When set to 0, there is no auto logout and Operators must manually logout (Operator/Operator Logon).

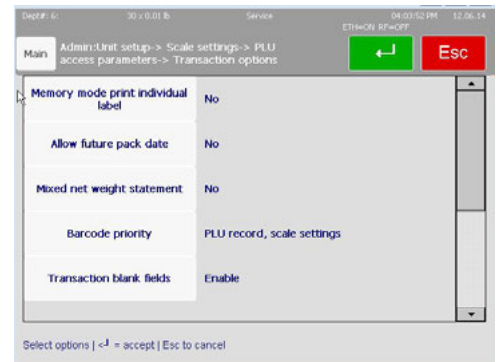



**Allow PLU force edit** – It is possible for PLU records to come down from host to have certain "force" flags set (i.e. force unit price, force tare 1 or 3, force PLU (manual mode), Force tare 2 or 4, force use-by date, force sell-by date). However, the scale settings could be set to not allow these in the transaction override fields, causing a conflict. "Allow PLU Force Edit" was added to resolve the conflict.

**Preset display page** – Select whether the default page should be the last used preset page or the home screen, when exiting a PLU transaction screen.

**Enable Australian Mode** - Default is NO for standard tare operation. YES selects the following (required for units sold in Australia):

- Disables preprogrammed tare.
- By-Count PLUs are not allowed.
- Fractional or "kg For" pricing is not allowed.
- Enables increasing tare requirement. (The next platter tare taken must be higher than the value on the display.)
- For Australia, also set the option tare field to use to NONE.

**Enable Merchandising** – Default is No and graphics for the labels are limited to 6k total size of the file. With a license key, Yes allows use of larger label graphics.

**Unique Item No.** – Default is no. When set to Yes, the same item number can be used for multiple PLU numbers.

**Date Forwarding Hour** – Default is 24. This is the hour after which the "Pack Date" will be incremented.

**By-Count Auto Clear** – When set to Yes, after a By-Count transaction (label printed or Memory) the PLU will clear and the scale returns to the home screen. When set to No, after a transaction the Clear button must be pressed to clear the PLU and return to the home screen.

Press **ENTER** when finished to save changes and exit.

## Barcode Settings

This menu is used to set the bar code that will print on the label. This must match the bar code system that is set up for the store.

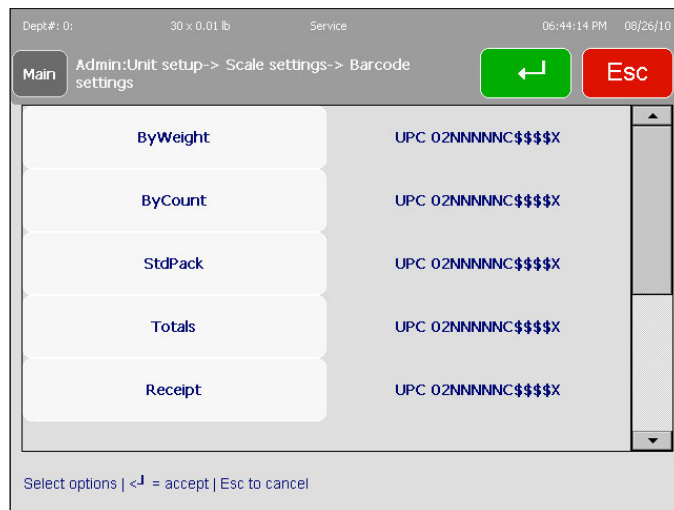

Each weighing mode can be assigned a bar code type. For example, to modify the By Weight bar code type, press the ByWeight button. The current bar code configuration will be displayed. On this screen, the bar code is set up currently for UPC.

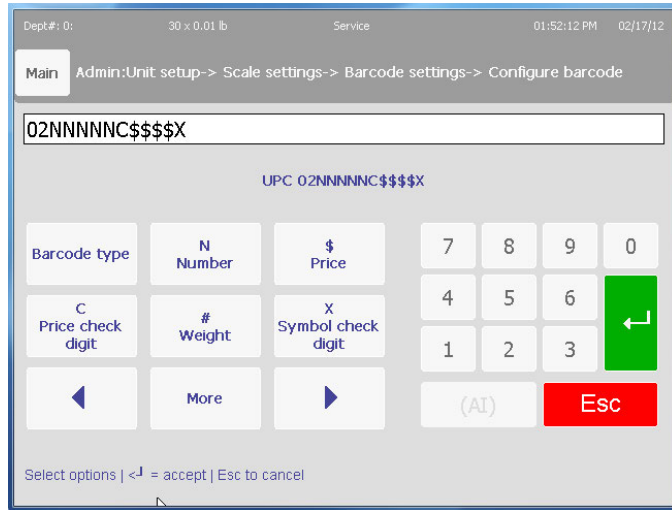

To select another bar code type, press the "Barcode Type" button. Press the button displaying the desired bar code type, or cancel.

**Bar Code Format Codes:**

- N Item number Digits.
- C Check Digit.
- 0 The number zero.
- \$ Total Price Digits.
- # Weight Digits.
- X Symbol Check Digit.

- 0 Type 0 Prefix (No price is encoded)
- 1 Type 1 Prefix (No price is encoded)
- 2 Type 2 Random-Weight, price encoded.
- 3 Type 3 Prefix (No price is encoded)
- 4 Type 4 Prefix (No price is encoded)
- 5 Type 5 Prefix (No price is encoded)
- 6 Type 6 Prefix (No price is encoded)
- 7 Type 7 Prefix (No price is encoded)
- 8 Type 8 Prefix (No price is encoded)
- 9 Type 9 Prefix (No price is encoded)

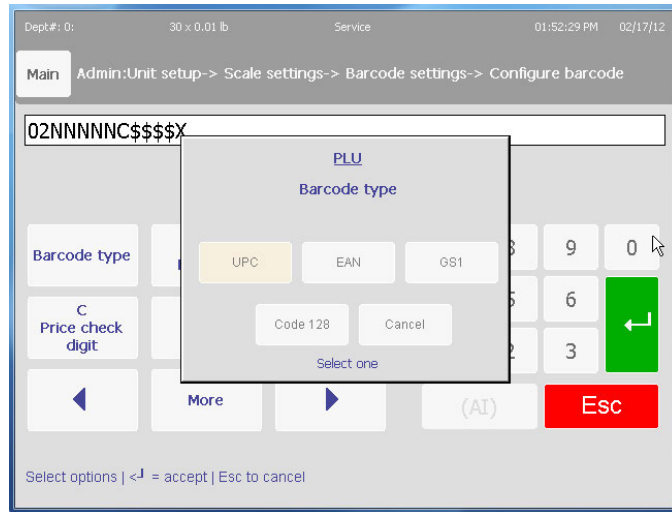

Example UPC Type 2 Barcode Symbol

Some scanning systems may require a price check digit and others may not. Check with the store IT department to determine the specifications required if the scanner will not recognize the bar code symbol.

Press **ENTER** when finished.

## GS1 Bar Code Setup

Press the "Barcode Type" button and select GS1.

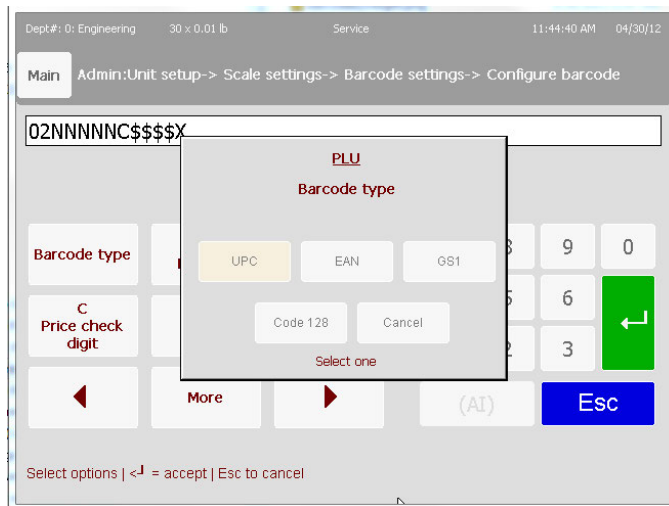

The GS1 Bar Code setup screen will display.

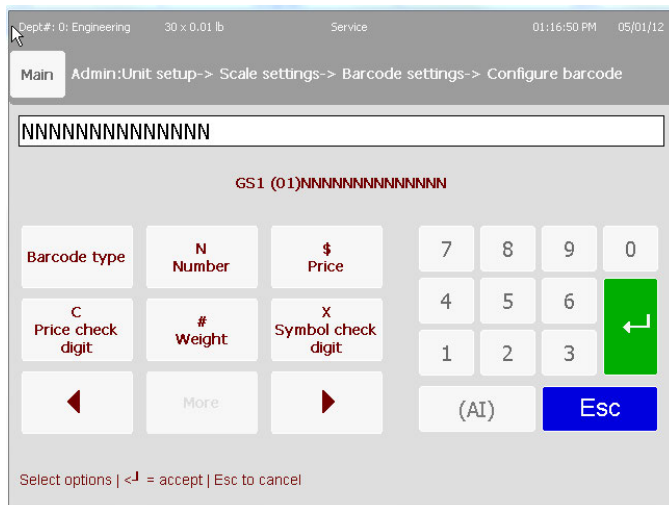

Some scanning systems may require a price check digit and others may not. Check with the store IT department to determine the specifications required if the scanner will not recognize the bar code symbol.

The GS1 Databar barcode type defaults to include the Application ID 01 or GTIN Number (the 14 digit item number of the PLU) only, indicated by all N's. Users can customize this to be something other than the GTIN Number by using the following barcode format codes:

Bar Code Format Codes:

- N = Item number digits
- C = Check digit
- 0 = The number zero
- \$ = Total price digits
- # = Weight digits
- X = Symbol check digit

Additional Application IDs are configured by selecting the (AI) button:

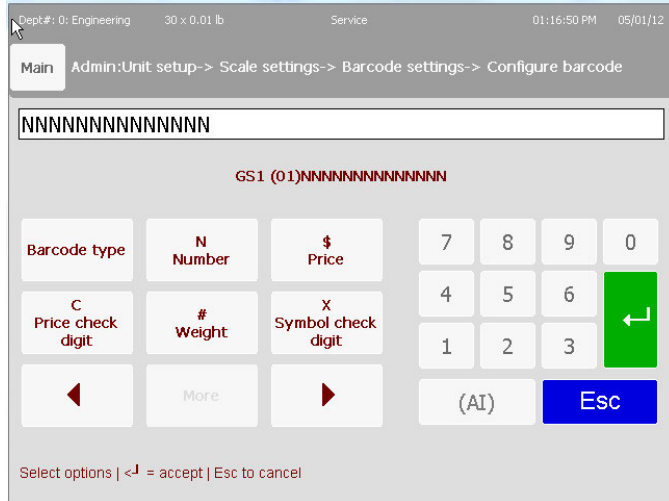

Select the AI you would like to include:

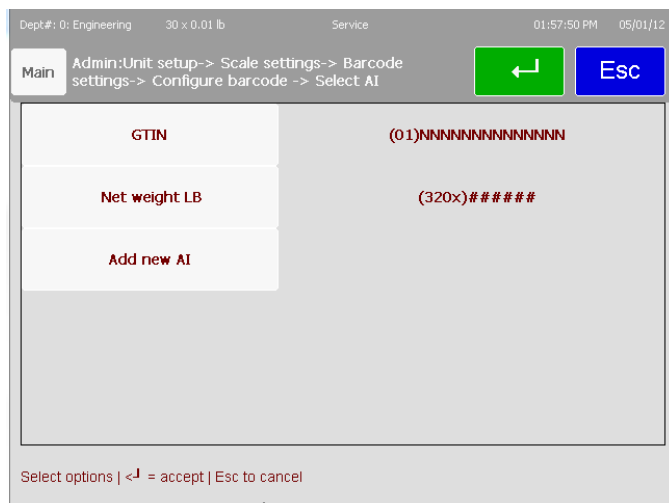
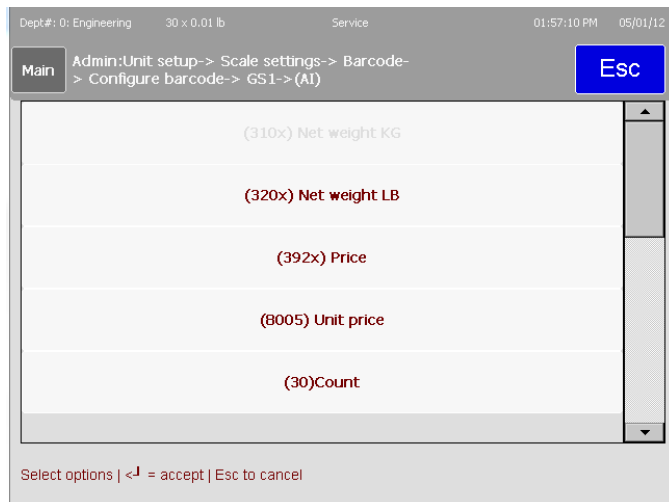

Continue to add AIs as necessary.

Other barcode settings related to GS1 Databar:

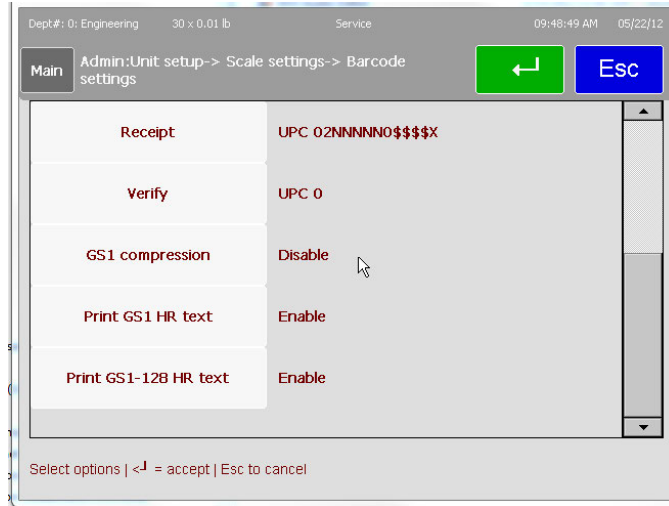

GS1 compression - compresses the GS1 Databar and makes it smaller (a 2D scanner is required)

Print GS1 HR Text option - Enable the Print GS1 HR Text option if you would like to print the Human Readable Text

To set up GS1 Databar at the PLU level:

Set the Barcode Priority (Unit Setup/Scale Settings/PLU access parameters/Transaction options) to PLU record, scale settings.

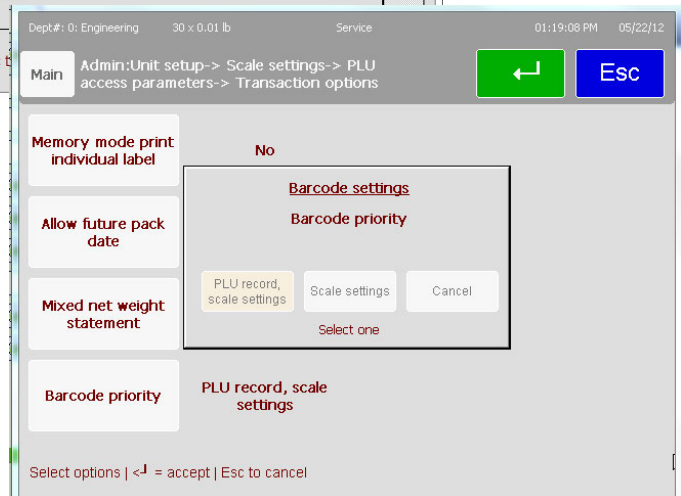
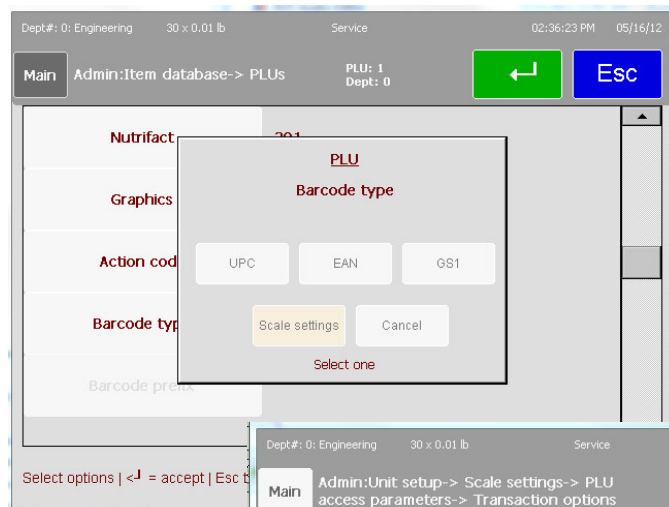

Select the GS1 elements (Application IDs) to include.

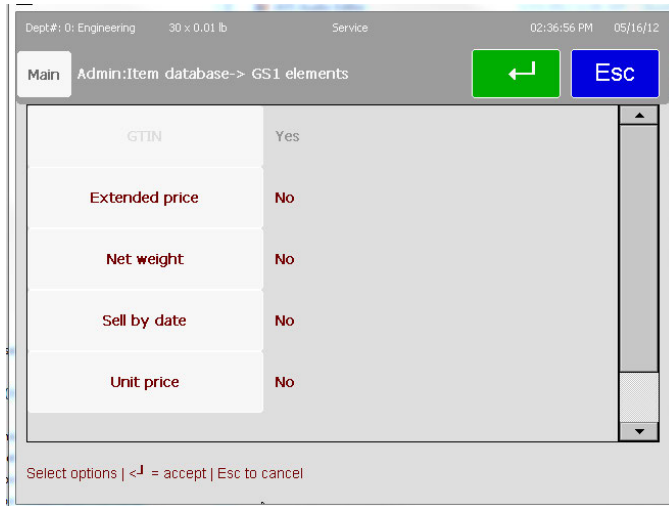

Barcode Samples:

GS1 Data with GTIN with human readable text



GS1 Data with GTIN without human readable text with total price, unit price, net weight and pack date.



GS1 Data with GTIN without human readable text, with total price, unit price, net weight, pack date, sell by date and use by date



## COOL

The **COOL Options** menu configures the COOL (country of origin labeling) functions such as COOL data is required or can be overridden and if the tracking function will show up.

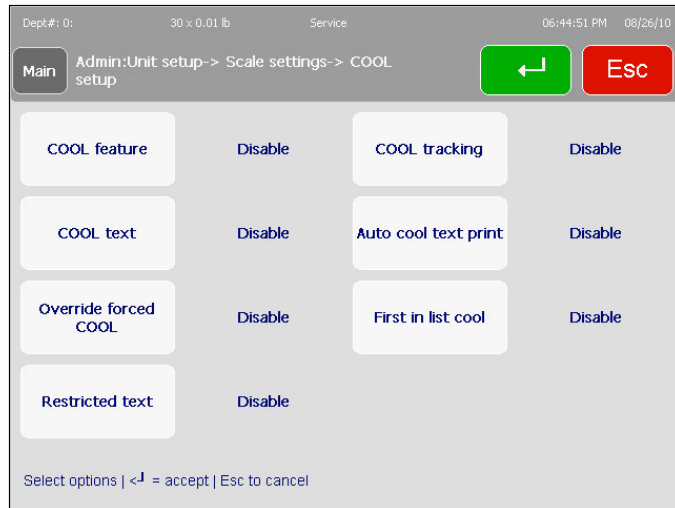

Touch to toggle, press **Enter** when satisfied with your setup.

## Store Logo

Select the image for the store logo. The store logo images must already be loaded in the unit database. The store logo is used to print on label formats that have this field configured in the format. The images for the store logo must be added using SmartX. The size (in pixels) for the images will depend on the label size in use. Standard labels with a width of 2.64" at 8/dots mm will be around 240 pixels for the full width of the labels. The size of the file is limited to 6k.

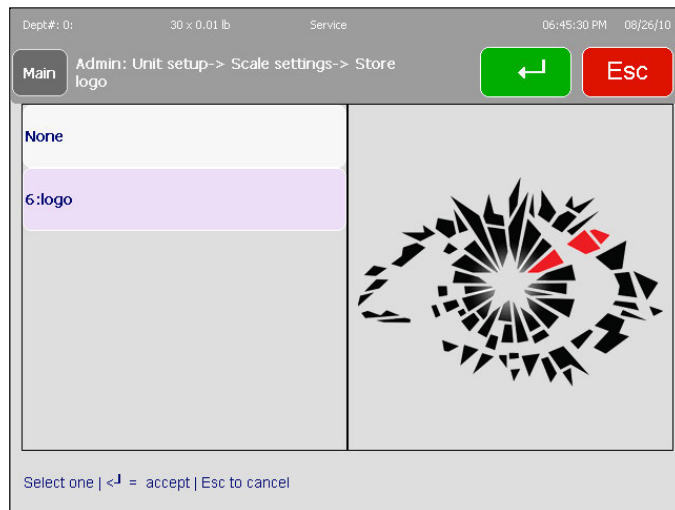

Press **ENTER** to select.

## Database

The Impact M can operate as a standalone unit with an internal database or as a client for connected on a network to a STEM (SmartTouch Ethernet Master) – a networked hub that holds PLU data. Standalone is the scale default setting. For Client mode, press the Client button. The scale must be restarted for the change to take effect.

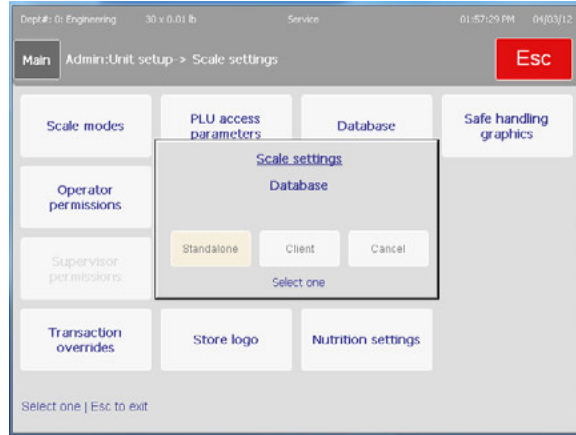

If the Impact M is changed to Client mode, after it reboots, navigate to Unit Setup/Communication to configure the STEM communications.

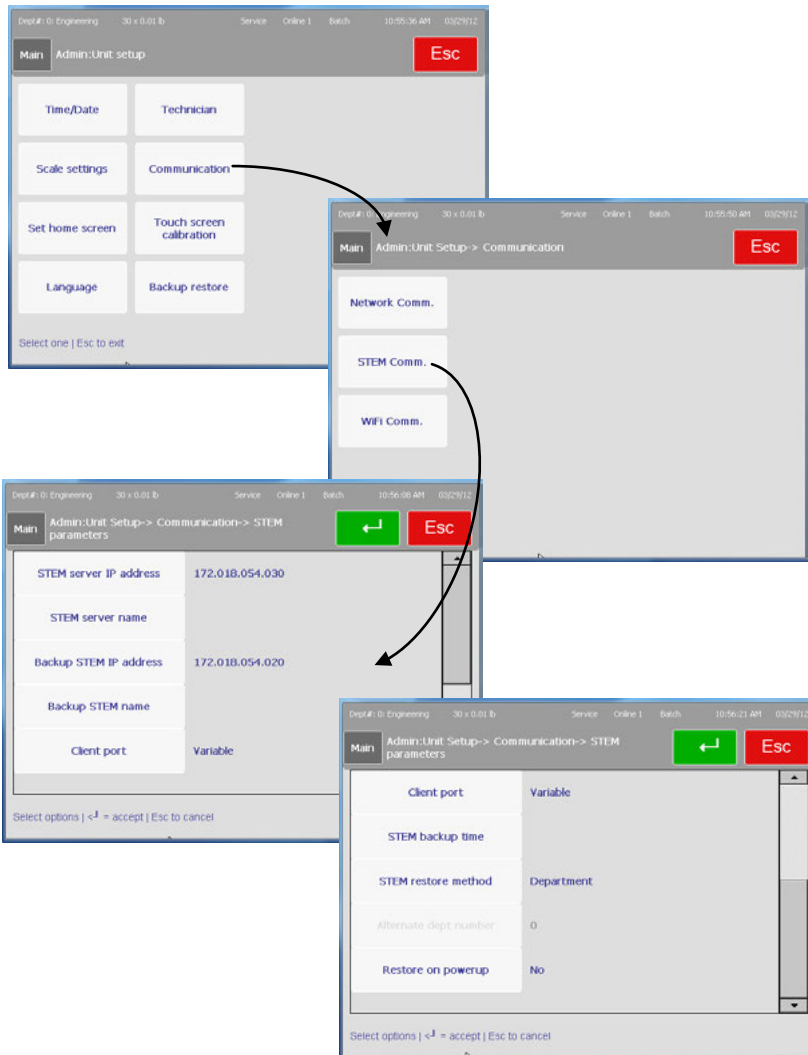



### Chapter 3: Admin Functions Unit Setup

In the list of options, find **STEM server IP address** press the box. Enter the IP address of the STEM and also enter a backup STEM address.

If the names of the main and backup STEM servers are available, enter those as well. Reboot the system. Upon power up, the scale will be entirely in client mode. When a PLU is entered or a data field is called up, the information will be taken from the STEM instead of the local memory. Furthermore, each time a PLU is called upon, it is stored in a special cache on the local memory, cutting down communication time between units (client and STEM) and allowing for a database of common PLUs to be built up in case of transmission failure on the STEM side.

Field	Value
STEM server IP address	000.000.000.000
STEM server name	
Backup STEM IP address	000.000.000.000
Backup STEM name	
Client port	Fixed

Once the information has been entered, back out to the **Admin Main** screen and touch the **Item Database** button. After entering a password (check with the local webmaster), the STEM Master Editor screen will display.

Button
Edit
Quick
Print
Report
Clear
copy
conFig
QUIT ESC

Master access Current Dept: 0 Ver: 4.2.09 D175013 Date: 09/14/10

This is the STEM database and any changes made here will affect every unit connected to the STEM. For additional information on the STEM, refer to the STEM User's Guide.

## Screen Saver

This will turn the operator screen saver on or off and configure the images displayed.

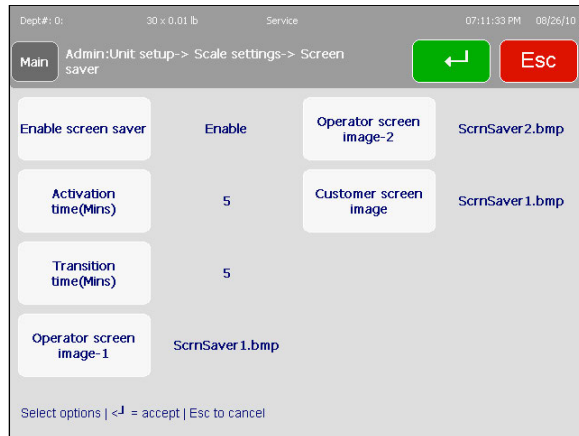

Press the "Enable Screen Saver" button to toggle the selection to "Enable" to turn on the Slide Show feature. Select the Activation time (delay before starting) and the Transition Time (time to display each image). Select up to three images with the "Operator Screen Image-X" buttons.

The Impact M comes with some default graphics installed. To add new images to the scale database, a licensed USB drive and Technician access is required.

- .BMP file format only. It helps to open and re-save these in Microsoft Paint before importing them, as many other programs use compression algorithms that are not properly decoded by the Impact M software.
- Color or Black and white.
- Starting point: Dimensions of 240 pixels wide by 240 pixels high. (The operator display can display a bmp about 640 pixels wide by 380 wide but its best to start at the 240x240 then tweak from there to get one that looks good).

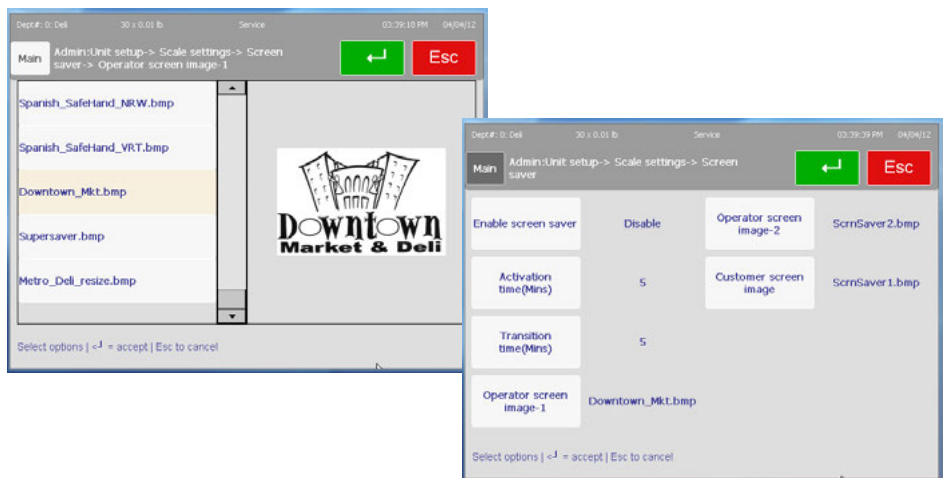

### Adding New Files

This function requires a license and a Technician Password. Navigate to Admin>Technician>Backup Restore>Copy Files. Select Copy From and select USB. Next, select the source file and select the type=.bmp. Open the desired bmp, select Copy To and then select "Default Graphics". Press Perform copy to start. Refer to Backup/Restore section for additional details.

## Preset Settings

Configure the operation of the preset buttons.

**Preset Reaction** – when set to **Edit**, when the preset buttons are pressed, the PLU screen opens and the Print button must be pressed to issue a label. When set to **Print**, when the preset buttons are pressed, the PLU screen opens and a label is printed automatically.

**Preset Type** – When set to **Graphical Preset**, presets may be assigned a graphic that displays on the preset button. When assigned to **Text Preset**, preset buttons will contain only text.

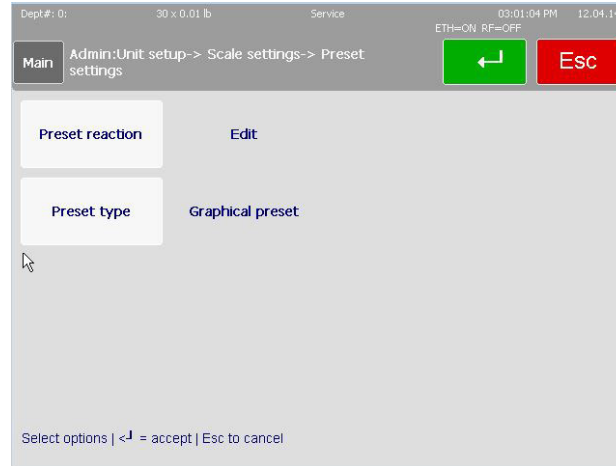

## Nutrition Settings

Nutrition Settings is used to configure the Nutrition Facts label format that includes the country, the type of NF panel, and the type of Meat NF panel. When Meat NF formats are selected, these currently will over-ride any NF record formats that are currently encoded in the record.



**US Tabular** (SW Version 1.1.12 and later) This format is used with a label style that contains the Meat Nutrifacts field. Refer the the next page for examples of this format printed.

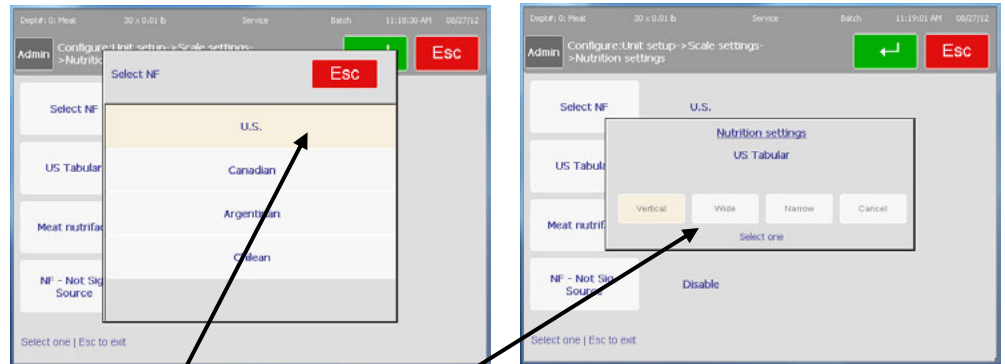

**NF - Not Sig. Source** (SW Version 1.1.12 and later) When "Enabled", the footnote "Not Significant Source of..." will print when any of the Nutrients fall below the significance level. When "Disabled", the Nutrition Panel will list all of the nutrients and their values including "0" and the footnote will not print.

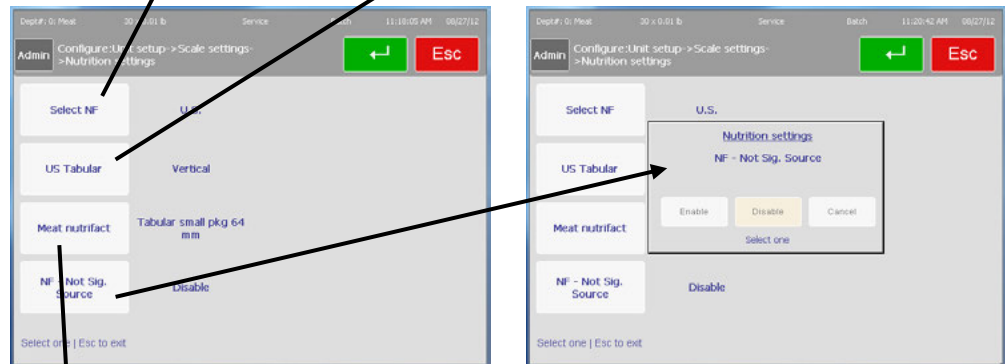

**Meat Nutrifact** (SW Version 1.1.12 and later) Select the format for the Meat Nutrifacts. This format is used with a label style that contains the Meat Nutrifacts field. Refer the the next page for examples of this format printed.

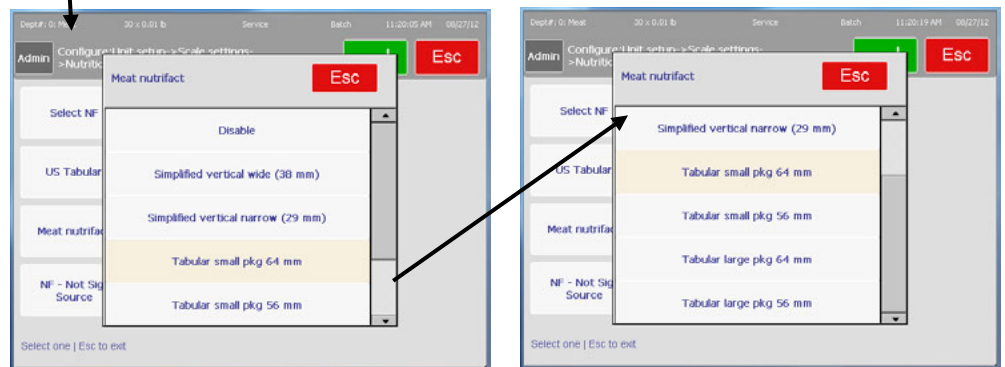

## 2011 Nutrition Facts Formats



Vertical



Tabular



Linear Landscape



Linear Portrait



Simplified Vertical  
Wide (38 mm)



Simplified Vertical  
Narrow (29 mm)

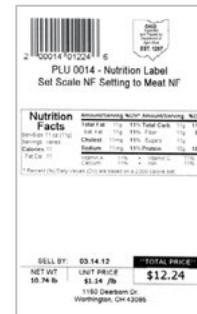

Tabular Small  
Pkg (64 mm)



Tabular Large  
Pkg (64 mm)

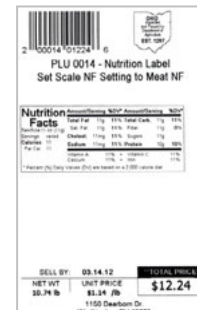

Tabular Small  
Pkg (56 mm)

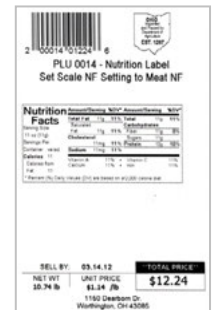

Tabular Large  
Pkg (56 mm)

## Safe Handling Graphics

Select the Safe Handling Graphics format printed on the labels from Wide, Narrow, or Vertical.



In order to print Safe Handling graphics, the label style must contain the Safe Handling Graphic field. Some standard formats contain the field and a custom style can be created. Refer to label styles for more information.

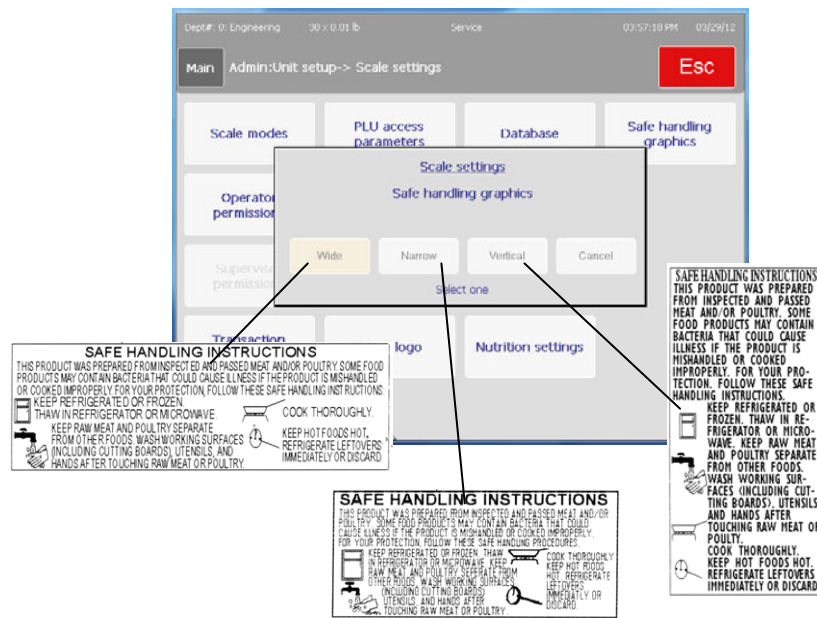

## Set Home Screen

Select the default preset screen. Touch to select the page, and then press the Enter button to save the changes.

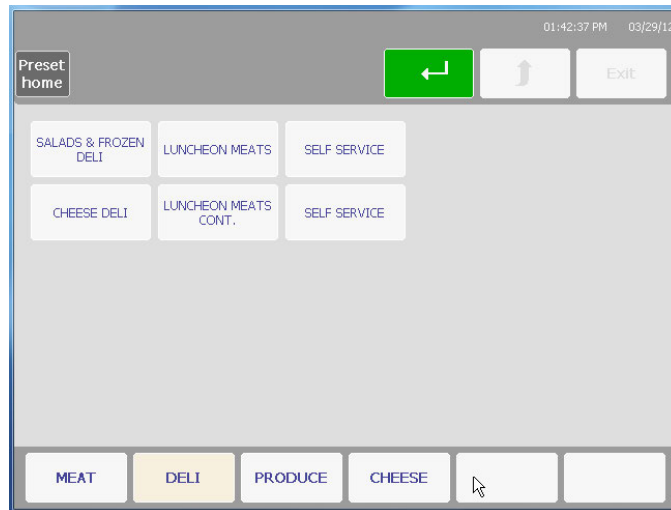

---

## Language

This menu enables you to toggle the display and keyboard languages between English, French and Spanish. Touch to select the field to cycle through the choices.

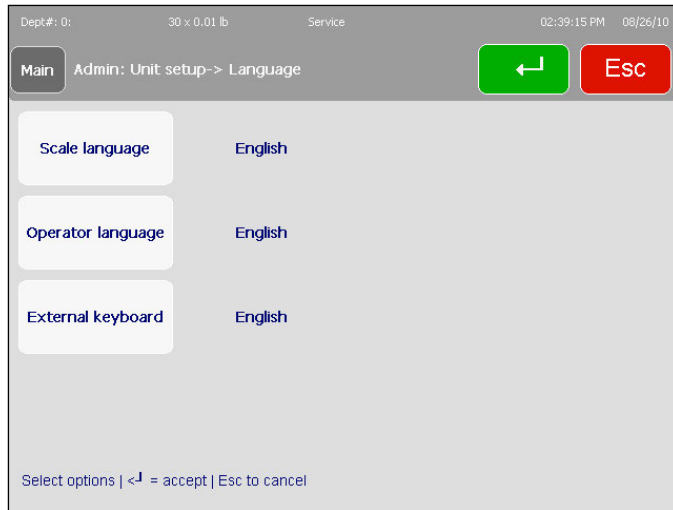

Press the **Enter** key when finished to save your choices.

---

## Technician

Password protected area for Service Technicians only.

---

## Communication

The **Communications** function configures networking parameters that enable the unit to network with other scales and devices.

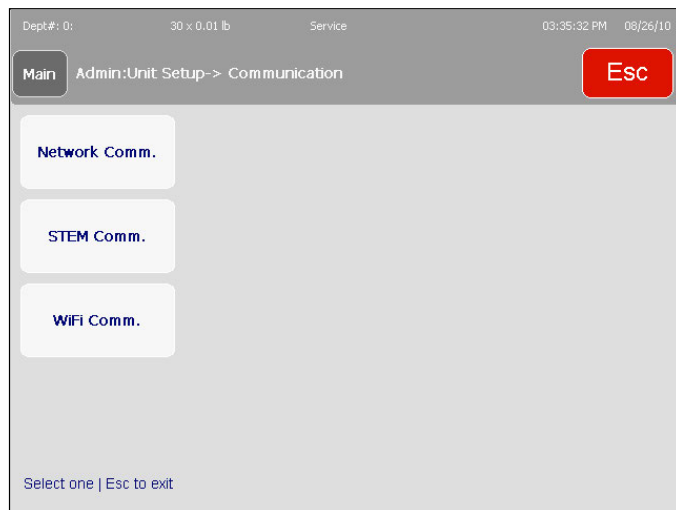

**Network Comm.** –Enter or modify network settings

**STEM Comm.** – Enter or modify STEM network configuration.

**WiFi Comm.** – Wireless networking configuration.

## Network Comm.

Configure Ethernet network parameters.

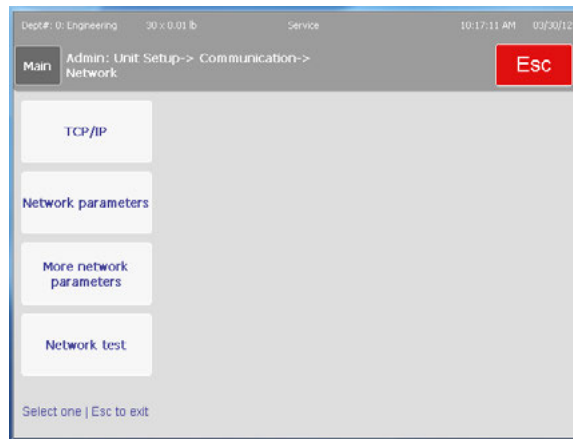

### TCP/IP

Configure Ethernet network settings.

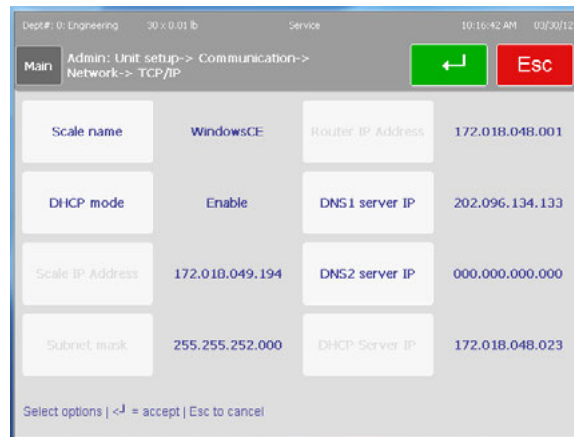

**Scale Name** – Scale name for the network.

**DHCP** – Enable or Disable DHCP mode. DHCP will automatically obtain an address from a specified DNS server. If a DHCP server is not available (such as when using a local network), the IP address must be Static.

**Scale IP Address** – When using DHCP, the address is assigned by the DNS server is displayed and the button is grayed out. If using a static address (fixed), press the button to enter the new IP address.

**Subnet Mask** – A subnet mask is used with an IP address to subdivide a network into smaller networks, allowing a greater number of nodes on a network with a single IP address. The Subnet Mask is the part of the IP address used to represent a sub network within a logical network. By using Subnet Masks, network address space is available that would normally be unavailable. Subnet Masks also ensure broadcasts are not sent to the whole network unless intended. The default Subnet Mask, 255.255.255.0, is recommended to reduce network traffic. When Subnet Mask, 255.255.255.0 is used, the broadcast range would be the local subnet only as follows:



**255.255.255.0 Subnet Mask**  
**207.142.140.XXX IP Address with a broadcast range of XXX.**

**255.255.0.0 Subnet Mask**  
**207.142.XXX.XXX IP Address with a broadcast range of XXX.XXX**

Using the Subnet Mask, 255.255.255.0, improves network performance by reducing broadcast traffic.

**Router IP Address** – If the server is on a different network (see Subnet Mask), the client will access the server by routing the request to the Default Gateway IP Address. The Gateway will route the request to other devices on the network to deliver the request to the server. The requested data from the server will then be routed through the Gateway to the requesting client. The Gateway must be on the same local network as the client.

**DNS1 Server IP** – This server IP is used for an Ethernet client to resolve a name to the IP address for communication which is easier for a user to remember. The purpose of a DNS server is to enable people and applications to lookup records in DNS tables. Most DNS servers are now private, meaning that they are configured to only provide service to the people and organizations who own and maintain them. A few domain name servers on the Internet provide DNS resolutions for anyone who requests it of them. These are known as "Public DNS Servers." Some free DNS servers are:

- OpenDNS Basic 208.67.222.222
- Google Public DNS 8.8.4.4
- Verizon 151.197.0.38 and 151.197.0.39
- Cisco 64.102.255.44 and 128.107.241.185

**DNS1 Server IP** – Secondary if DNS1 is not available.

**DHCP Server IP** – Displays the DHCP server IP address.

### Network Parameters

Configure the network **Time Sync Server** or **Host Communications Port**).

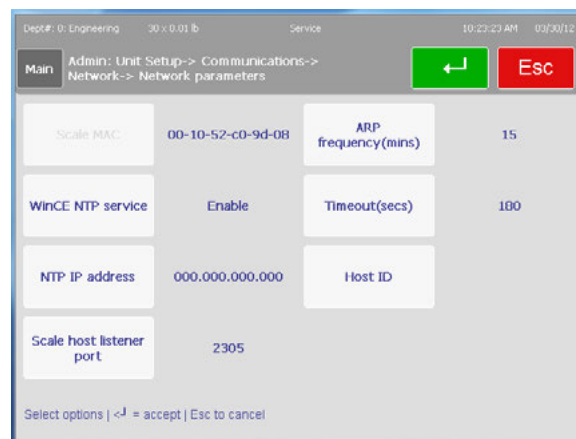

### More Network Parameters

Configure Directed Ping and NIC Start Delay.

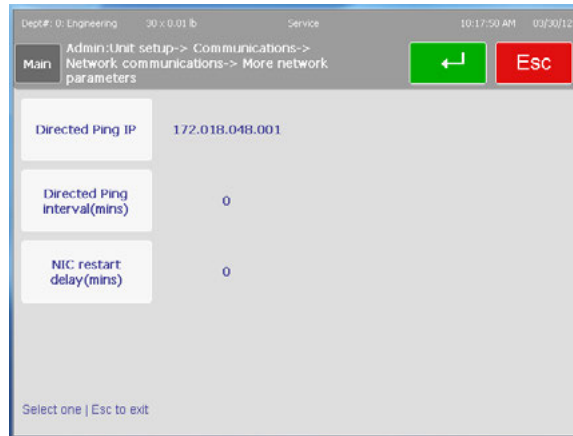

**Directed Ping IP** – Enter the IP address of a server or access point that will be pinged at the desired interval as a keep-alive communication. This is useful when using the standalone mode where an IP lease may be lost if regular communications are not keep up with a server or access point.

**Directed Ping Interval** – Enter the value in minutes between pings.

**NIC Restart Delay** – Enter the amount of time in minutes to delay a ping to allow time for a wireless card to re-establish connection on a power up.

### Network Test

Used to test a network connection by checking the online status of other scales or devices on the network using Ping. Press the **Ping Test** button, key in an IP address, and press the Ping button. A window will display with the results of the test.

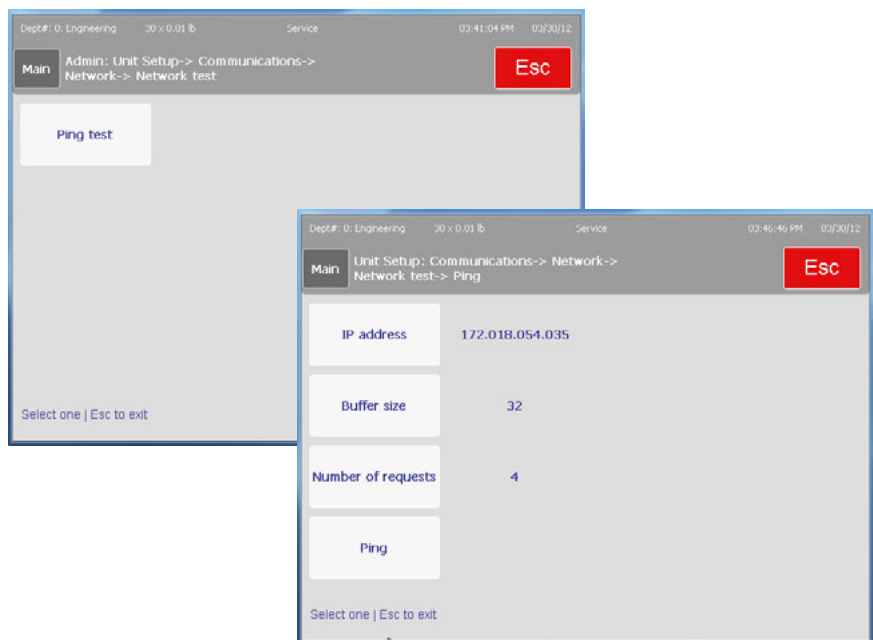

## STEM Comm.

Configure the STEM communications with the client.

STEM server IP address	172.018.054.030
STEM server name	
Backup STEM IP address	172.018.054.020
Backup STEM name	
Client port	Variable

**STEM Server IP Address** – Enter the IP address of the primary STEM.

**STEM Server Name** – If a name is available, enter the STEM name. This is the local domain name of the scale server, which may be a STEM or PC

**Backup STEM IP Address** – Alternate or backup STEM IP address.

**Backup STEM Name** – Alternate or backup STEM name.

**Client Port** – The STEM Client Port can be Variable or Fixed.

Client port	Variable
STEM backup time	
STEM restore method	Department
Alternate dept number	0
Restore on powerup	No

**STEM Backup Time** – Set the backup time for a backup to the client for the local database, department information, and presets. The default is 3:00 AM.

**STEM Restore Method** – Select Normal, Department, Current and Alternate Department, Presets only. The Normal method is based on what is in the scale’s backup memory (files accessed previously). Department will restore all of the PLU and other files in a specified current department. Presets will only restore PLUs assigned to a preset button.

**Alternate Dept Number** – If an alternate department is configured, it will display here.

**Restore on Powerup** – Select restore when power is turned on, Yes or No.

## WiFi Com

This screen is used to change the wireless radio configuration based on installed hardware, software and specific network preferences and requirements.

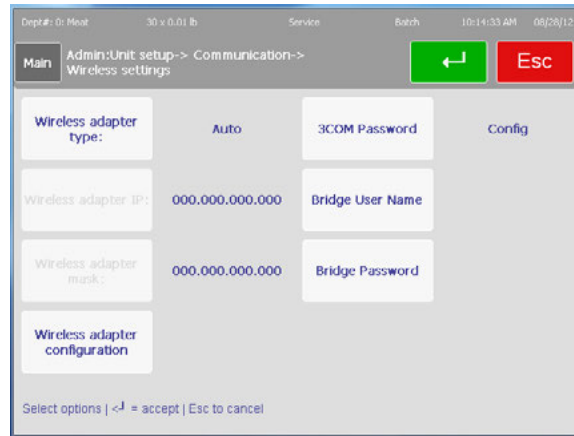

**Wireless Adapter Type** – Select the radio installed in the Impact M from Auto, MTWA5, MTWA4, or WGB3 (3COM).

**Wireless Adapter IP** – Displays the current network IP address.

**Wireless Adapter Mask** – Displays the current network mask.

**Wireless Adapter Configuration** – Setup the wireless card configuration.

Wireless Settings	Description	MTWA5	MTWA4	WGB3
Network Status	Shows current connection status of the radio and the MAC address of radio	X	X	X
Radio	Disables or Enables Radio	X	X	X
ESSID	Name of the currently connected wireless network	X	X	X
Encryption method	Select from None, WEP, WEP LEAP, WPA, or WPA2	X	X	X
No Security	<b>Security Encryption method/Network Configuration</b>	X	X	X
Shared WEP 40/64 BIT		X	X	X
Open WEP 40/64 BIT		X	X	X
Open WEP 128 bit		X	X	X
Open WEP 128 BIT 4 KEY		X	X	X
WPA-PSK-TKIP		X	X	X
WPA-PSK-AES		X	X	X
WPA2-PSK-CCMP-AES		X	X	X

Wireless Settings	Description	MTWA5	MTWA4	WGB3
WPA2-PSK-CCMP-TKIP	<b>Security Encryption method/Network Configuration</b>	x	x	X
LEAP - Dynamic WEP		x		x
LEAP- AES		x		x
WPA- 802.1x PEAP		x		x
WPA EAP-FAST		x		
WPA 802.1x TTLS/PAP		<b>*See Note 1</b>		x
WPA 802.1x TTLS/MS-CHAP2		x		x
WPA2- 802.1x PEAP		x		x
WPA2 EAP-FAST		x		
WPA2 802.1x TTLS/PAP		<b>*See Note 1</b>		x
WPA2 802.1x TTLS/MS-CHAP2		x		x
Clone scale MAC		Use the scale MAC address instead of the radio MAC address		x
Radio Configuration	Select Auto, 2.4GHz, 5GHz	x		x
Rate	Select data rate 'best' or a specific speed	x		
MAC aging				x
DHCP	Enable or disable DHCP			x
Radio IP address	Displays the radio address currently assigned or press the button to enter a static IP			x
Radio subnet mask	Displays the current subnet for the network or press the button to enter a new subnet mask			x
Radio gateway IP address	Displays the current Gateway IP for the network or manually enter a new address			x
Radio name	Display the currently installed radio name			x

Wireless Settings	Description	MTWA5	MTWA4	WGB3
Bridge Password	Enter the bridge password			X
Time				X
AP Scan		X		X
Extra command	Place for Additional commands, not supported by menus	X		
Reset all	Resets the configuration data in the scale to factory defaults	X	X	X
Reset Bridge to Factory Default		X	X	X
Apply configuration - Bridge synchronized	Press to apply new configuration 'bridge synchronized' will display when the configuration matches the setup of the radio			

**3COM Password** – Enter the password used for the 3COM card.

**Bridge User Name** – Enter the bridge user name for the network.

**Bridge Password** – Enter the bridge password.

**\*Note 1:** Need to add entry in extra command: eap-phase2 autheap=PAP

MTWA5 Enterprise Authentication Chart					
Authentication Type	User Name	Password	CA root	EAP User ID	EAP Phase 2
LEAP - Dynamic WEP	Required	Required	n/a	n/a	n/a
LEAP- AES	Required	Required	n/a	n/a	n/a
WPA- 802.1x PEAP	Required w/o certificate	Required w/o certificate	Not commonly used	n/a	MSCHAPV2
WPA 802.1x TTLS/PAP	Required w/o certificate	Required w/o certificate	Not commonly used	Not required. If entered, typical value = anonymous	<b>*see Note 1 above</b>

MTWA5 Enterprise Authentication Chart					
Authentication Type	User Name	Password	CA root	EAP User ID	EAP Phase 2
WPA 802.1x TTLS/MS-CHAP2	Required w/o certificate	Required w/o certificate	Not commonly used	Not required. If entered, typical value = anonymous	<b>*see Note 1 above</b>
WPA2 802.1x TTLS/PAP	Required w/o certificate	Required w/o certificate	Not commonly used	Not required. If entered, typical value = anonymous	MSCHAPV2
WPA2 802.1x TTLS/MS-CHAP2	Required w/o certificate	Required w/o certificate	Not commonly used	Not required. If entered, typical value = anonymous	MSCHAPV2

## Touch Screen Calibration

This function is used to reset the screen accuracy. There is a built-in timeout in case the function is accidentally selected. When the timer counts to zero, the scale will return to the previous screen.



To calibrate the touchscreen, touch the center of the circular graphics as they appear, waiting until they shrink to a small point and you are prompted to let them go. For added precision, you can use the tip of a stylus.

## Backup/Restore

The **Backup/Restore** feature will save data to a storage device (internal, external USB flash drive, etc.). This same menu will also allow a restore from a previous saved backup. This menu requires a licensed thumb drive and a technician password to enable the feature.

The **Export Log** feature will move log files to \service\log directory for export.

**Copy files** copies data from the compact flash card to an external USB device.

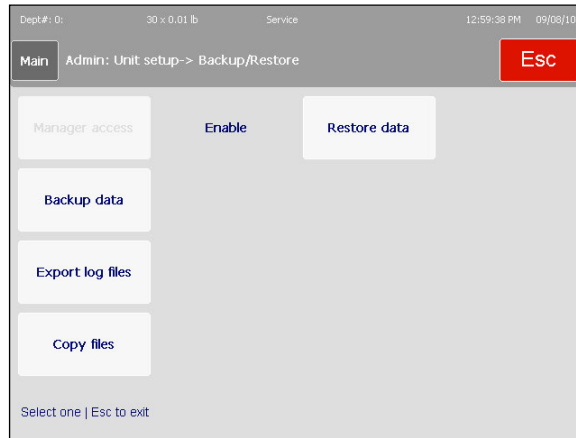

**Backup** – Touch to select a category and then press the button to toggle through the groups. Press **Enter** when finished making your selections and press **Backup** (move slider to the bottom) to begin the transfer process.

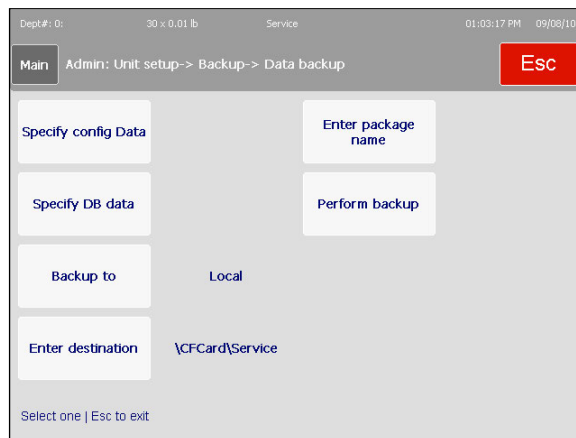



The **Restore** function allows you to select an existing file from a storage source with which you may repair or overwrite your current data. Select the file and follow the prompts.

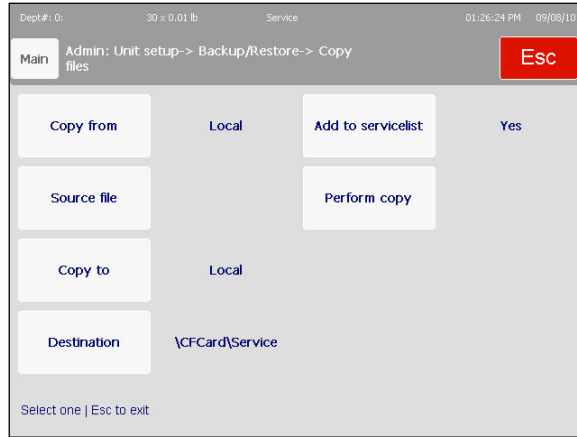

**Copy** and **Export Log** work in the opposite way, allowing you to select your file and copy them to a particular location via a Windows-style browser view.

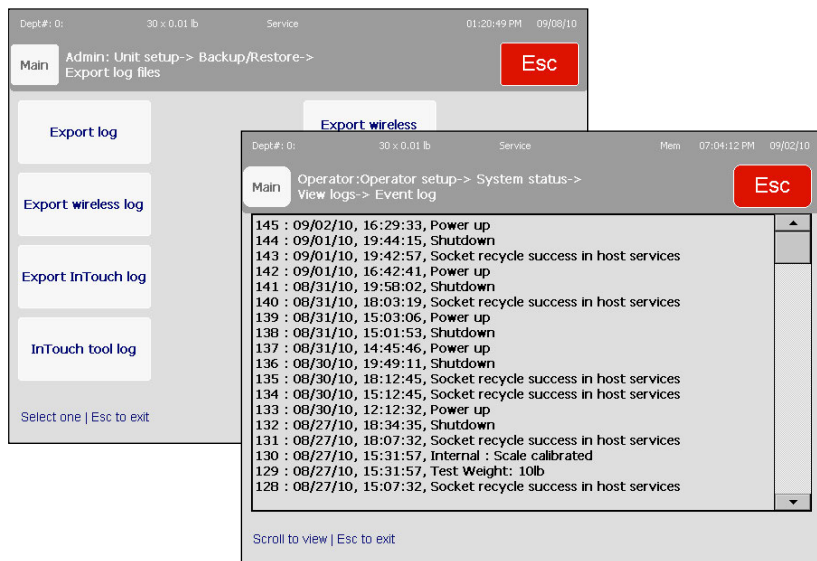

## Printer Setup

The **Printer Setup** menu is accessed from the main configuration screen.

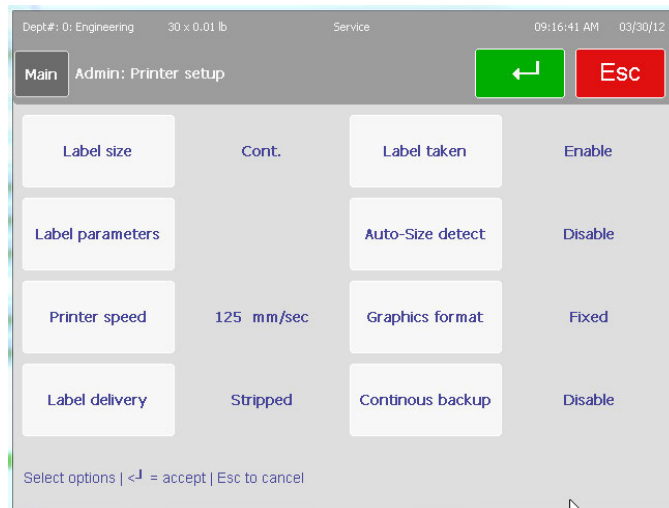

This screen deals specifically with the label parameters and printer sensor calibration of the Impact M unit.

**Label size** – press to select from a list of default label sizes. Default label sizes include 1.9”, 2.1”, 2.4”, 3.3”, 4.2”, 4.7”, 5.1”, and Continuous. Custom sizes from 1” to 12” can be used. If the length is not listed here, configure a custom size in Label Parameters.

**Label parameters** – This screen is used to set the physical label dimensions and to calibrate the printer sensors. See the next section following.

**Printer speed** – press to select from a list of print speeds

**Label Delivery** – toggle between “Stripped” and “Unstripped”

**Label taken** – toggle between “Enabled” and “Disabled”

**Auto-Size detect** – toggle between “Enabled” and “Disabled”. Enabling auto size matches a label group to the current label stock after the unit measures it upon printing.

**Graphic Format** – this selection is for continuous label stock, toggle.

**Continuous Backup** – When using continuous stock labels, disable prevents the printer from backup before it starts printing. Enable allows a starting backup of the label stock.

Press **Enter** to accept changes to any fields.

## Label parameters

**Label parameters** includes elements such as the label length, gap length between labels, image offsets and sensor calibration.



**Label Length** – Custom lengths can be configured. This value will be overwritten by Measure Label.

**Gap length** – specifies the gap, in millimeters, between two labels.

**Image Offset** – allows the user to fine-tune the start of the label text and graphics on the label stock.

**Eject Length** – alongside label and gap length measurements, **Eject Length** tells the printer how far to feed the stock so stripped labels are easily retrieved from the exit without falling to the floor. Also insures all printed material is shown after tear-off of continuous.

**Measure Label Length** – Make sure the correct labels are loaded in the printer. Be prepared to catch the labels ejected as the scale measures the label length. This will overwrite the value currently in the Label Length function.

**Calibrate Gap Sensor** – Make sure the labels are loaded in the printer and be prepared to catch the labels ejected as the sensor is calibrated.

**Calibrate Label Taken Sensor** – Calibrates the front sensor used to detect when a label is still on the printer label shelf.

**Printer Contrast** – Selects the energy level when printing from 0-8 where 8 is maximum. Press the **Enter** key when finished.

## Security

The Impact M has various integrated security protocols that can be configured. Through the use of the **Security** screen, new users with different permissions may be added to the system. A login screen will be presented.

It is **STRONGLY** recommended that the password and user ID be changed by the technician servicing this scale. Contact your local Mettler Toledo service organization if you would like to set up on-scale security features.

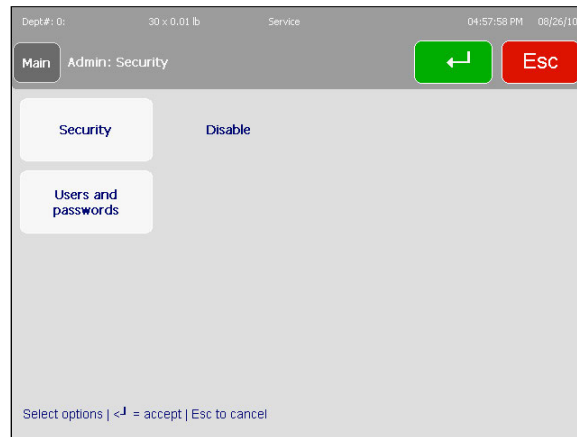

Most of the functionality of the Security menu exists within the first of the two buttons. After making any changes, remember to press the **Enter** key to save.

**Security** – this field is a toggle that switches between “Enabled” and “Disabled” for the scale. Only Managers and Technicians can change this state.

Users may take advantage of/edit/create at any level of the system that is equal to or lower than their own. For example, a Technician can modify anything a Manager, Supervisor or normal Operator can, but a Supervisor may only modify his own set of screens and any of the Operator screens.

**Users and passwords** – Use this button to add or edit the specifics of various user profiles. There are four levels of user than can be defined:

- Operator – has access to transaction screens only. No permission to access setup menu when security is enabled
- Supervisor – has access to transactions and item database setup menus. No permission to access weights and measures significant parameters.
- Manager – has access to all supervisor-class screens/menus as well as scale setup menus.
- Technician – has access to all screens, including full setup and calibration menus.

## Users and passwords

This menu contains the functions to **Add**, **Modify** and **Delete** users.

The screenshot shows a terminal window with the following content:

```

Dept#: 0:          30 x 0.01 lb          Service          04:58:41 PM  08/26/10
Main  Admin:Security-> User admin      [Enter] [Esc]
Add user
Modify user
Delete user

Select one | Esc to exit
  
```

To input a new user into the system, press the Add button.

The screenshot shows the user creation form in the terminal window:

```

Dept#: 0:          30 x 0.01 lb          Service          05:25:37 PM  08/26/10
Main  Admin:Security-> User admin      [Enter] [Esc]
User ID          0
User name
User type        Operator
Password         *

Select options | <J = accept | Esc to cancel
  
```

Enter an ID number, a user name, and a password number. Next, select the access level – operator, technician or supervisor.

- Operators have no access to setup menus (no password required, obviously)
- Supervisors cannot create/edit a technician's permissions – just other supervisors and operators. Password protected (passwords must be between 2 and 9 characters long)
- Managers can create/edit permissions for all but Technicians. Password protected.
- Technicians can alter anyone's permissions. Password protected.

## System Status

The **System Status** menu is used to determine version information, setting the comprehensiveness of the **Log** function and viewing the existing logged data.

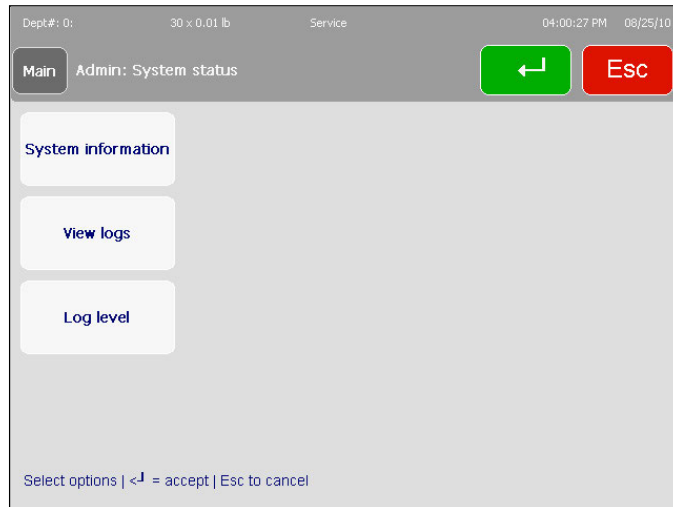

**System information** – brings up a list of current system versions and addresses

**View logs** – array gives user access to the various log lists

**Log level** – allows user to choose between “**Level 1**,” “**Level 2**” and “**Level 3**” to set the log detail level. Level 1 is minimal and 3 is maximum log details.

## System Information

The **System Information** window is a read-only screen that displays various versions and addresses for the unit. As shown below, PLU, ET and NF values are stored alongside user-editable (within other menus) content such as scale names and IP addresses.

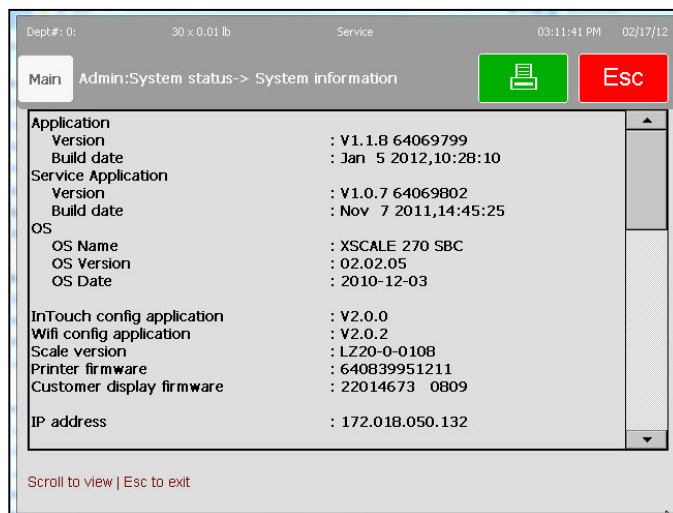

## Log View

This section allows the viewing of logged data. Touch – **Event** or **Error** – edit the filter parameters and press **Display Log**.

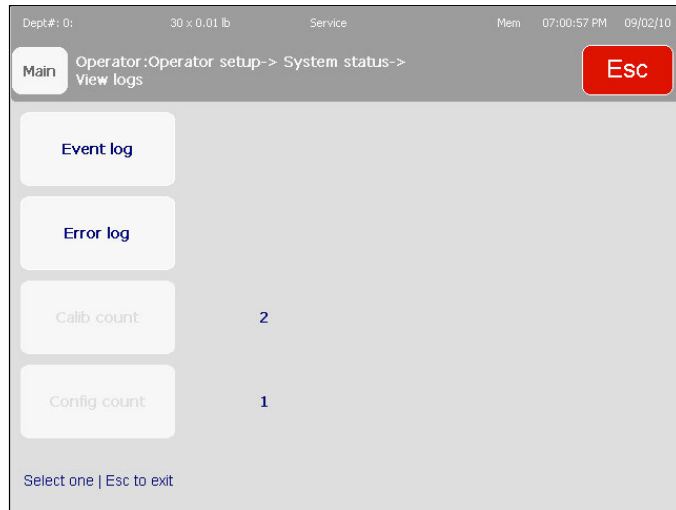

**View Event Log** – this menu displays a comprehensive list of the actions taken to modify the parameters of the scale. Everything from on-and-off times to when specific PLU display modes were modified can be listed here, assuming you have the **Log Level** set high enough. This scrollable list can be limited by date or specific event type.

**View Error Log** – displays any errors that have occurred within the timeframe selected.

**Calibration and Configuration Counter** – these read-only fields represent the following:

**Calibration Counter** – represents the number of times the load cell has been calibrated.

**Configuration Counter** – displays the total number of times a weights and measures parameter edit has been performed by a technician.

## Log Level

The **Log Level** menu sets how comprehensive the log function is.

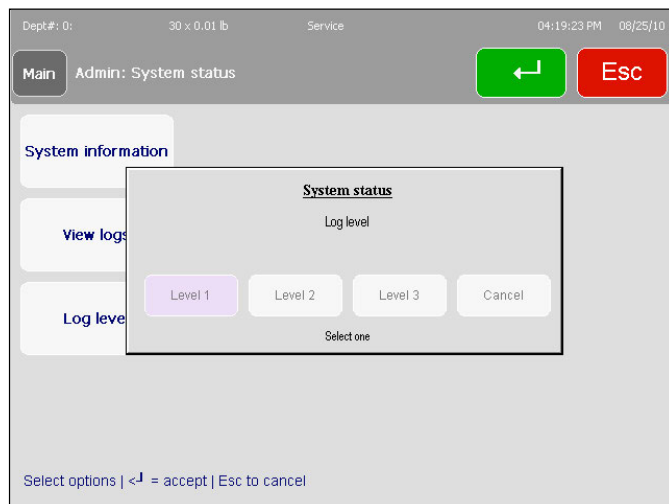

Level 1 is minimal and Level 3 is maximum log details.

## Quick Edits

The Quick Edits feature is used to modify common fields in a PLU record. Only numeric data can be entered in this mode. To modify other fields, such as description, extra text, etc. use the Item Database function.

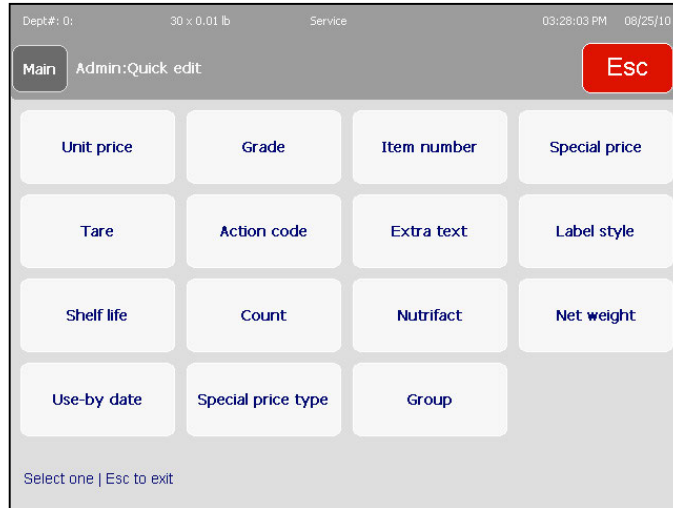

After keying in a PLU number, the Quick Edit Screen will appear. Press one of the PLU field buttons on the screen.

Each selection will bring up either an appropriate key pad or a new window to enter the data.

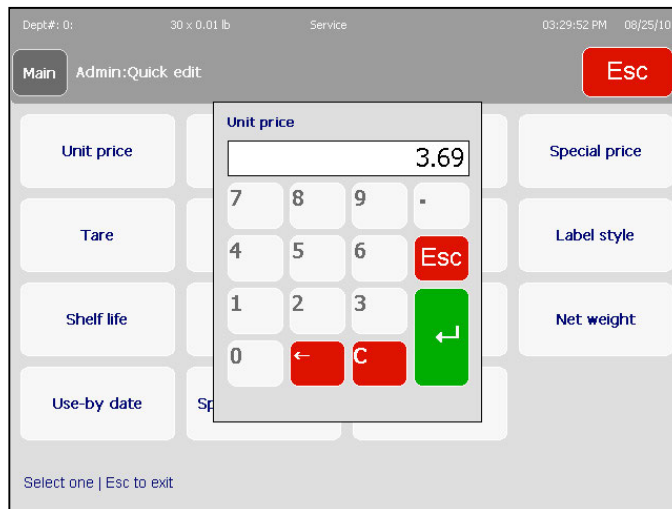



## Select Department

When you press the **Department** button from **Unit Setup** you will be prompted for the department number you would like to modify. After touching a number, you will be asked whether you want to **Edit** or **Clear** an existing entry. Make your choice or press **cancel** to exit to the **Admin home** screen.

Dept#: 01      30 x 0.01 lb      Service      03:12:54 PM      08/25/10

Main      Admin:Select department      <-      Esc

0	1	2	3	4
5	6	7	8	9
10	11	12	13	14
15	16	17	18	19
20	21	22	23	24
25	26	27	28	29

Select one | <- = accept | Esc to cancel

# Marquee

The **Marquee** is used to edit the messages and images on the customer display.

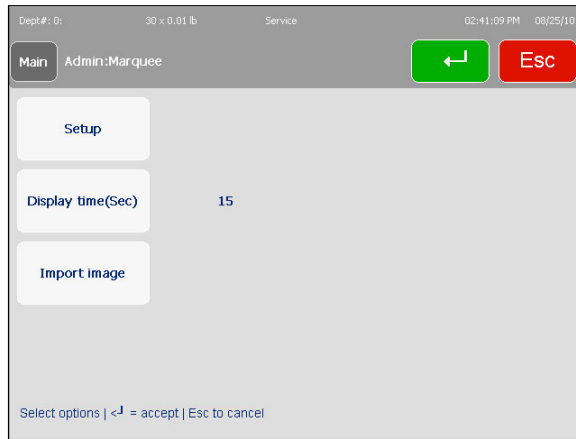

**Setup** – Setup messages and images that will appear in the marquee.

**Display time** – Set duration, in seconds, to display each message or image.

**Import image** – import a new graphic from an outside source (USB).

# Setup

Setup is used to construct marquees by selecting text messages or images that will appear on the customer display.

Scroll down to a blank line and press it to create a new entry, or press one of the existing message lines to edit.

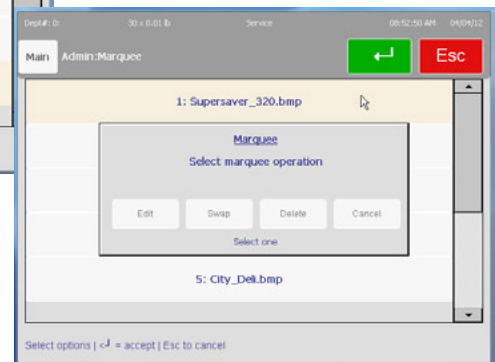
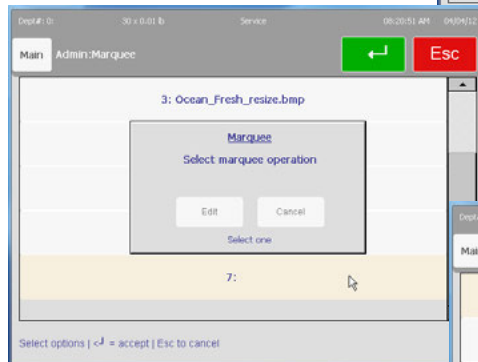

On this screen, Edit, Swap, and Delete functions are available. To create a new entry or modify an existing one, press the Edit button. Select the type of message, Text, Action Record, or Graphics.

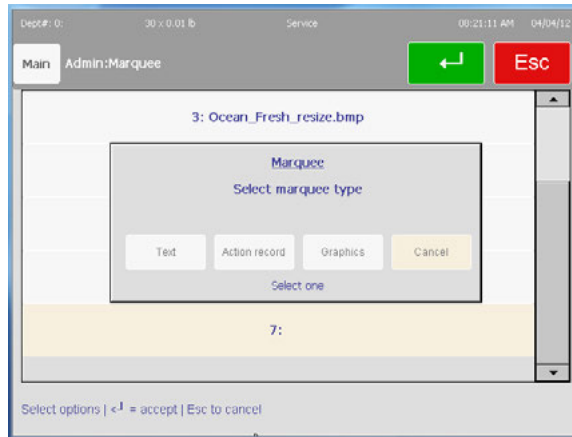

Text marquees allow entry of a text message and will open the on screen keyboard.

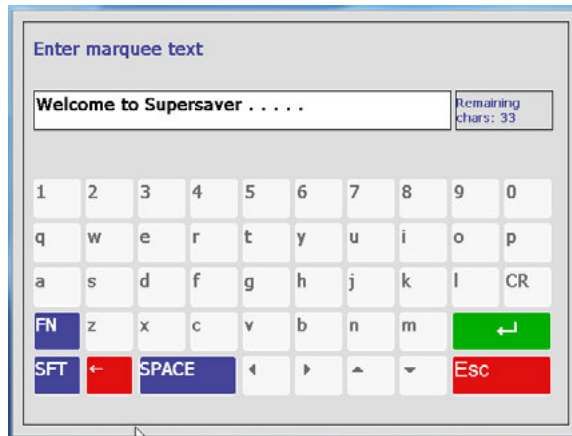

Action Record messages must be already loaded into the Impact M from a host system such as SmartX.

Graphics must also be loaded prior to creating the marquee using the Import Image function. Touch the file name on the left to select and preview the image. Press the green Enter button to accept the image or ESC to cancel.

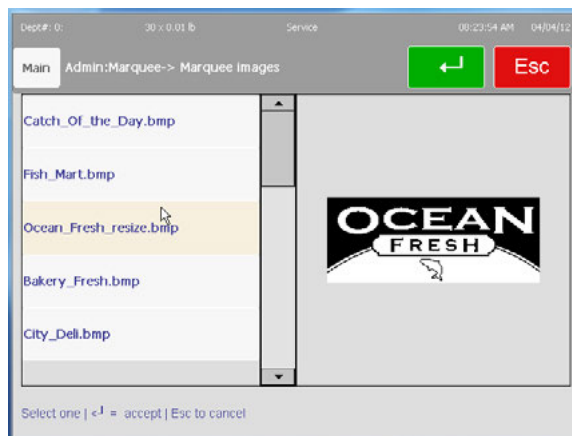

## Import Image

**Import Image** is used to import new images to the Impact-M's database. Imported images **MUST MEET** the following requirements to properly display on the Impact M customer display screen.

- .BMP file format. It helps to open and re-save these in Microsoft Paint before importing them, as many other programs use compression algorithms that are not properly decoded by the Impact M software
- Black and white. The files must be converted to grayscale/black and white or they will not display properly.
- Maximum Dimensions are up to 320 pixels wide by 190 pixels high. 240 pixels wide is a good starting point.

To copy from a USB drive, first insert the USB drive in one of the USB slots located on the lower front under the operator display.

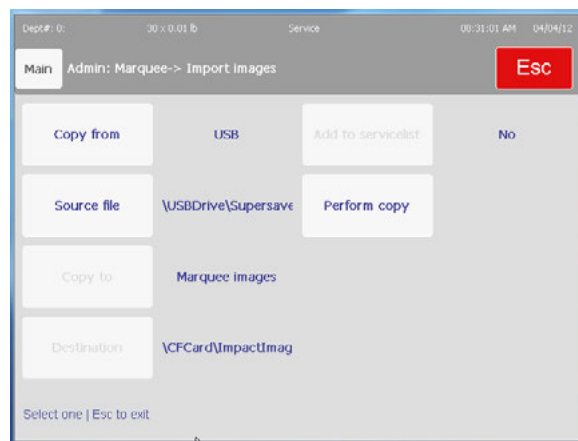

**Copy From** – USB or Local. In most cases, select USB unless the file has been transferred by host.

**Source File** – Select the file using the file browser.

**Perform Copy** – Copies the selected file from the selected location.

## Self Service Mode Setup

Self Service mode allows the grocer to place a scale on the store floor and permit the customer to serve themselves. In this mode only required buttons are displayed. The Admin button is active but hidden in this mode and access into any setup requires a password. An example Self Service Screen is shown below. PLUs can be called by entering the PLU number, selecting a preset key, use "Search", or scan a barcode (if equipped with scanner).

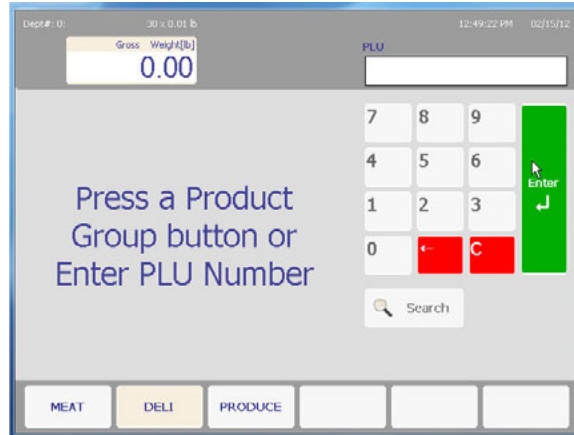

To use Self Service Mode, the scale must be set up as a Category 1 Scale and Security must be enabled. The Scale Mode can be checked by navigating to the Unit Setup/Technician screen. If it currently shows Category 1, the Security mode can be checked. A manager or supervisor password may be required to check this. If security shows "Disable", it must be enabled before Self Service mode can be used. See the next section for details.

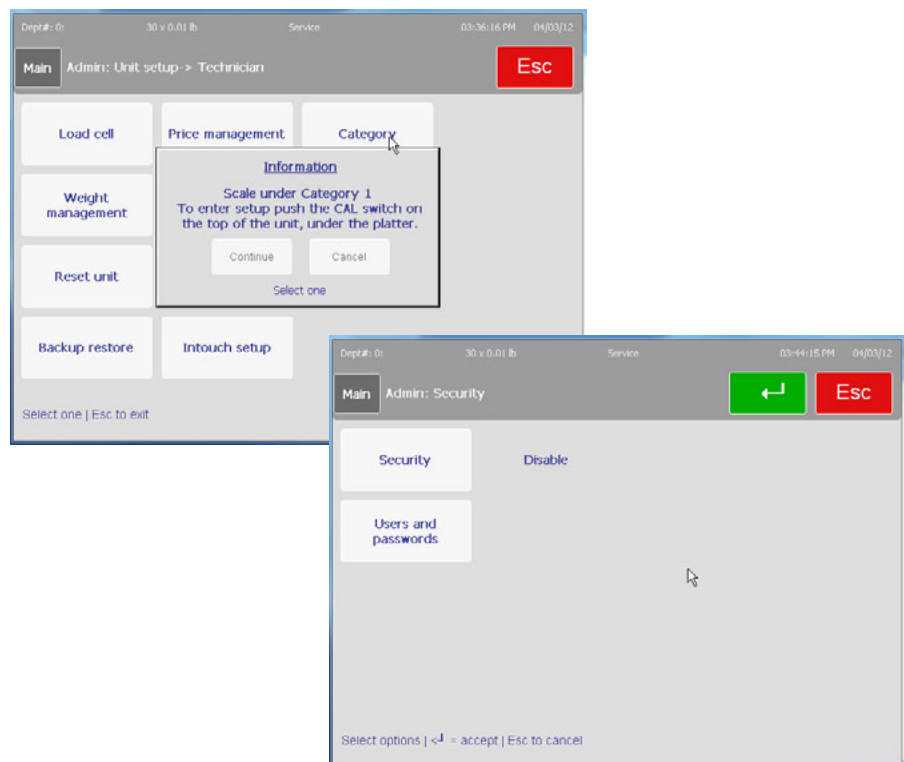

Enter the Admin screen by pressing the Admin button. The supervisor ID and password will be required if Security has been previously enabled. New scales from the factory will normally come with security disabled.

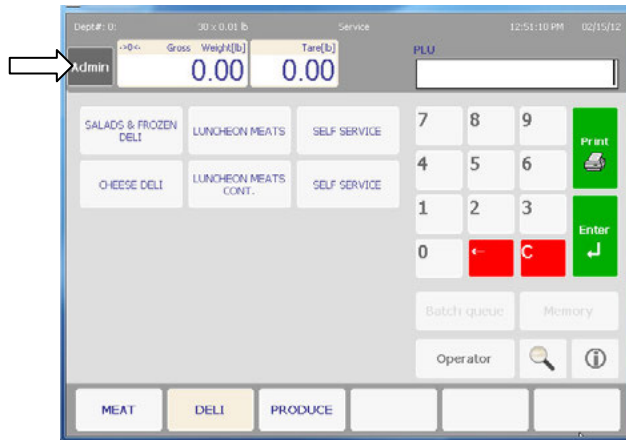

First, enable security by pressing the Security button. Select Enable. Next, press the "Users and Passwords" button. Create a new user with supervisor permission and assign a password. Click the green return button to save and exit.



### Chapter 3: Admin Functions Self Service Mode Setup

From the Admin screen, press the Scale Settings button and then the Scale Modes button. On the Scale Modes box, press the "Self Serve" button to enable the Self Service Mode.

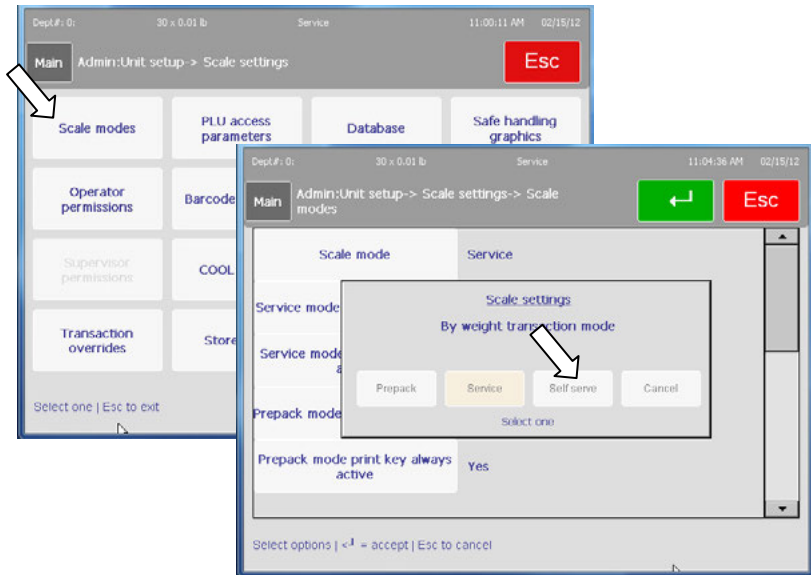

Configure other items on the Scale Settings screen relating to Self Service as needed. For example, select the Keypad and Self Service Prompts to display as a default.

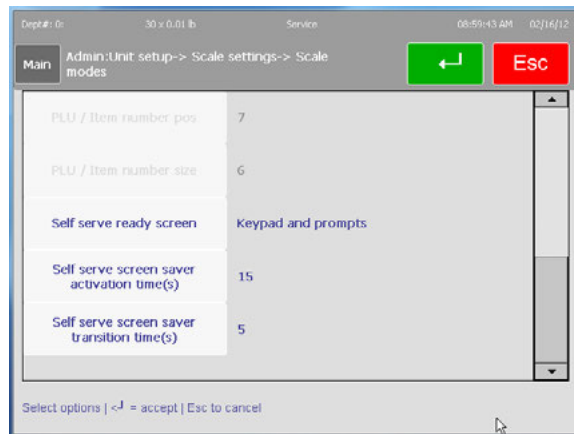

Other options include Presets and Prompts and Presets and Keypad. Examples are shown below.

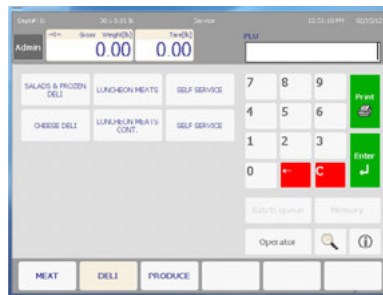
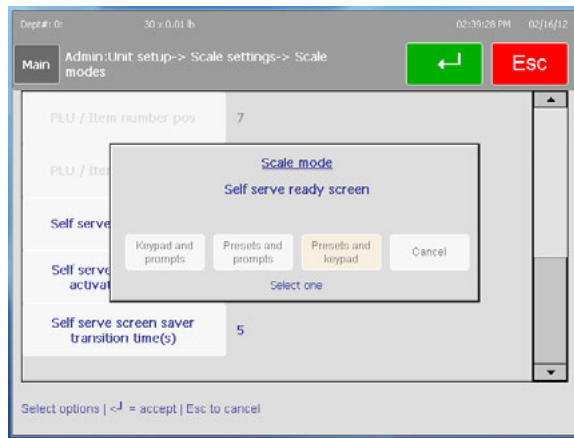

**Keypad and Presets**



**Keypad and Prompts**



**Presets and Prompts**



### Chapter 3: Admin Functions Self Service Mode Setup

Press the green Enter button to save and exit. To edit any of the Self Service mode prompts, press the "Self Serve Prompts Editor" from the Admin screen.

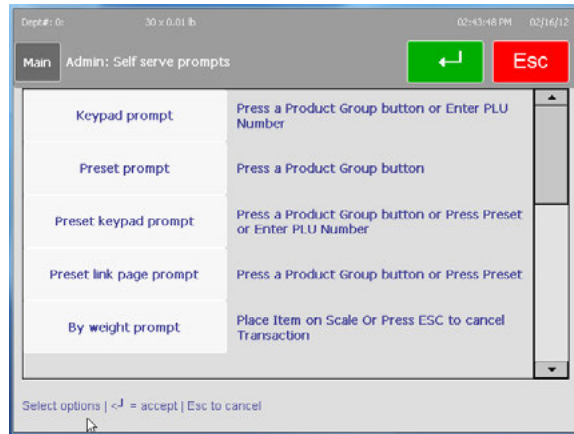

Press any of the prompts to modify them. For example, when the "Keypad prompt" is pressed, you can select default, custom, or graphics prompts.

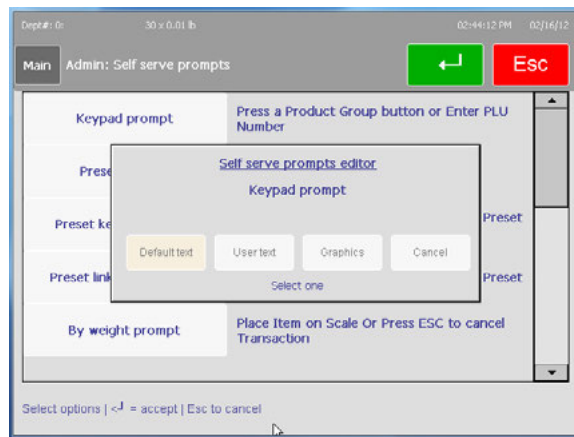

Example of Presets with Prompts

Press the "User Text" button to enter a custom message.

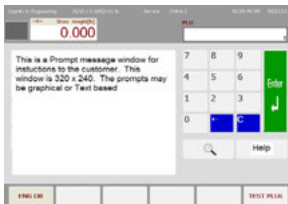
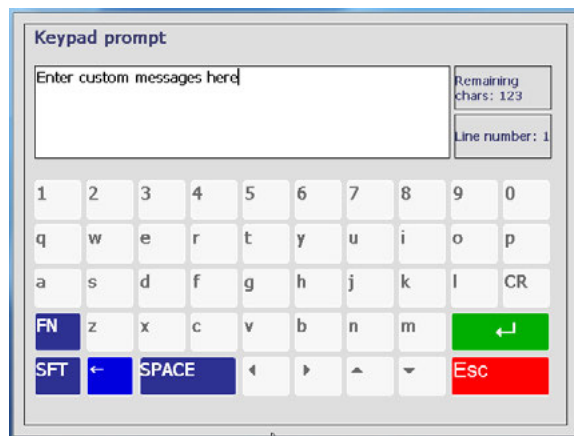

Example of Prompts with Keypad

Press the green Enter button to save and exit or the red ESC button to cancel.

When done, press the "Main" button to return to the main screen.

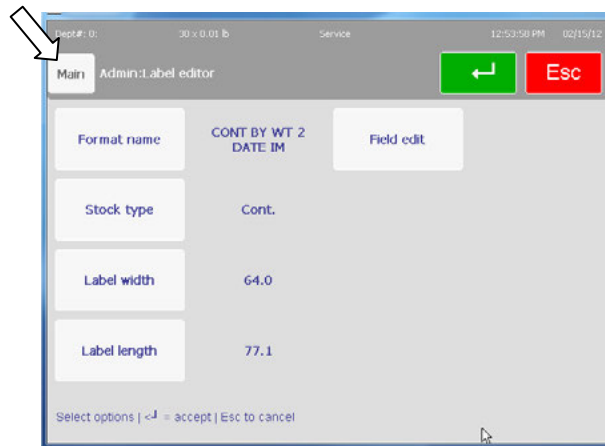

## Label Editor

The Label Editor is built in tool for creating or editing label formats. To access the Label Editor, press the Admin button and then press the Label Editor button.

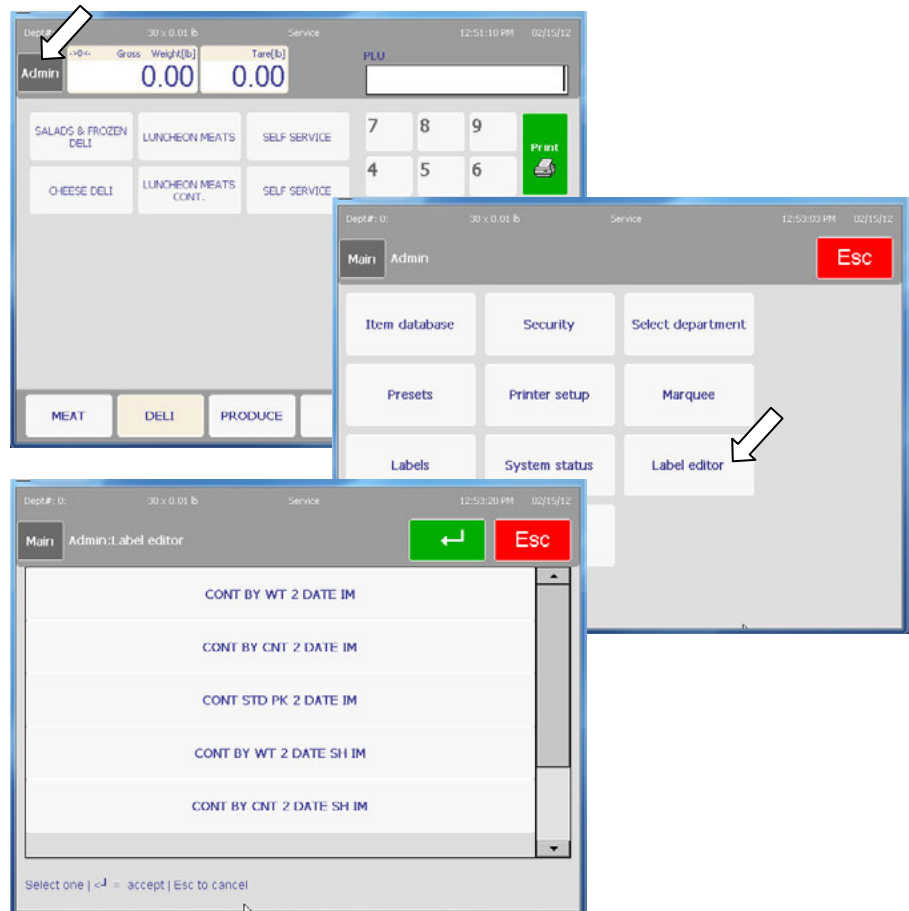

The Label Editor will display the currently configured label formats. To modify a style, press one of the styles listed on the screen.

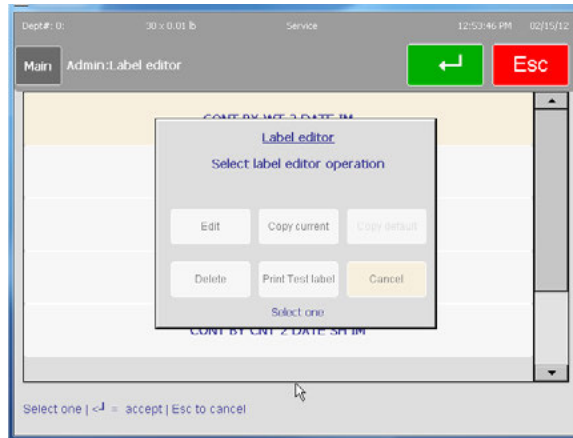

Select one of the options, Edit, Copy Current, Copy Default, Delete, or Print Test Label. For example, to edit a style, press the Edit button.

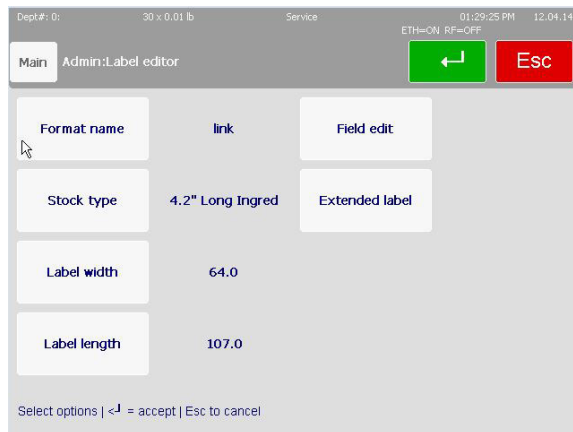

The style contains the label parameters such as name, stock type, width, length. To change any of the parameters, press one of the buttons. To edit the fields that are configured, press the Field Edit button.



The Fields currently configured in the format will be listed along with the location of where each will print on the label. The label coordinates are shown in millimeters (mm) starting

at the top left of the label as the zero starting point of Top 0, Left 0. A 3.3 inch (84mm) label is shown below as an example.

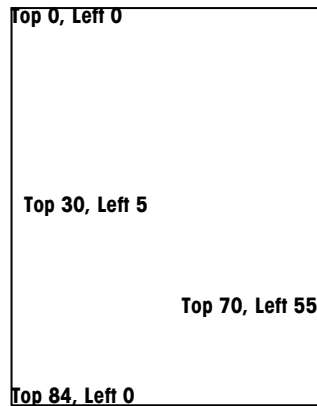

**Label Coordinates in Millimeters - Label Editor**

To add a field, press a blank row at the bottom of the editor.



Select the type of field.

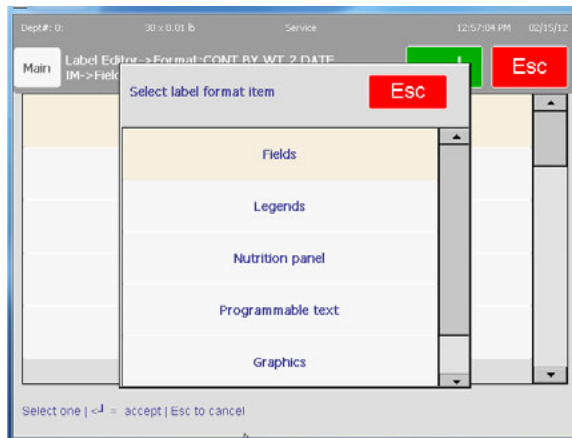

For example, pressing the "Fields" button will open the field selector window.

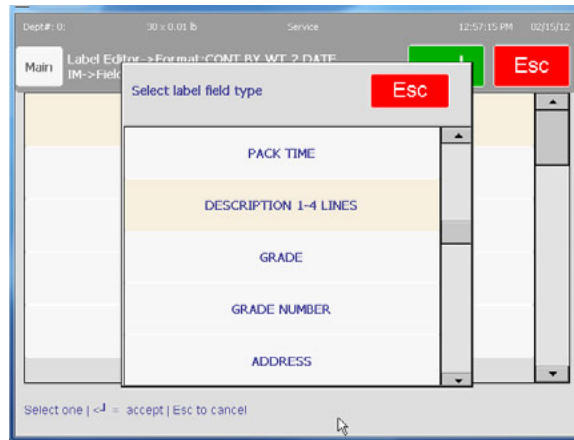

Press to select the field type. The field coordinates and other parameters can then be entered. Make sure to set the width of a field. If it is left zero, it will not print on the label.

Press the green Enter button when done to save and exit or the red ESC button to exit without saving.



## Label Format Graphics

Graphics can be assigned to label formats. For example, a sale graphic could be assigned to a sale label format. To assign a graphic to a label format, choose the label field type 'Graphics Image'.

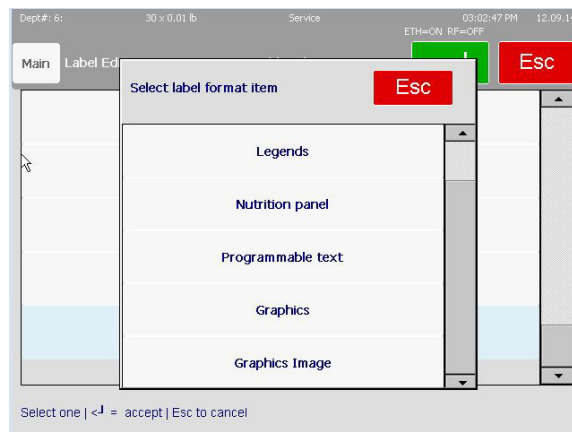

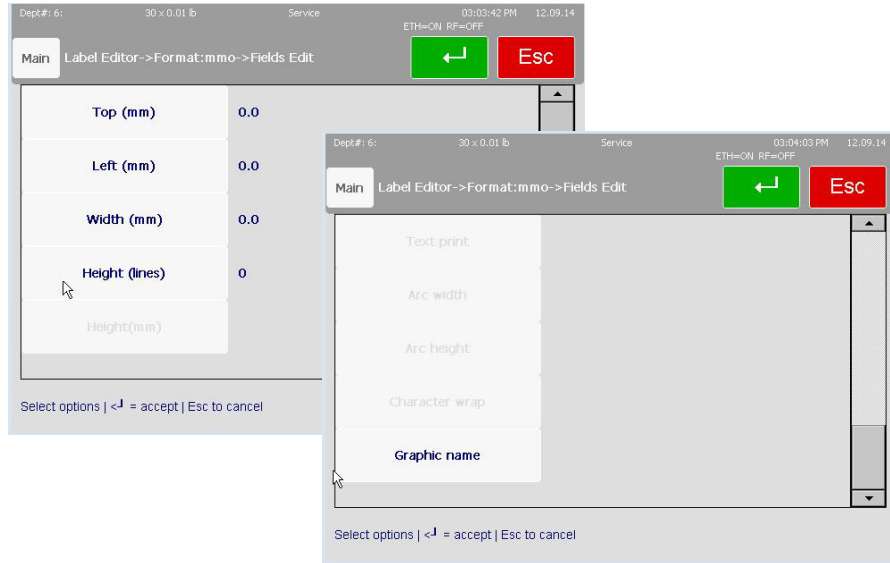

Select the placement of the image then choose the graphic by selecting the 'Graphic Name' field. A list of available graphics will display. Refer to the Service Manual for information on importing graphics.

## Extended Label

Extended Labels allow users to link label formats together to allow for up to 3 different types of label formats (1<sup>st</sup>, 2<sup>nd</sup>, and extended) to print for a PLU transaction. Extended labels also allow extra text to print over multiple labels (as many as needed). This is beneficial for long ingredients lists. When using the extended label settings, the 'parent' label should not have any fields (in the field edit screen). Rather, the 'parent' label is made up of the extended label formats.

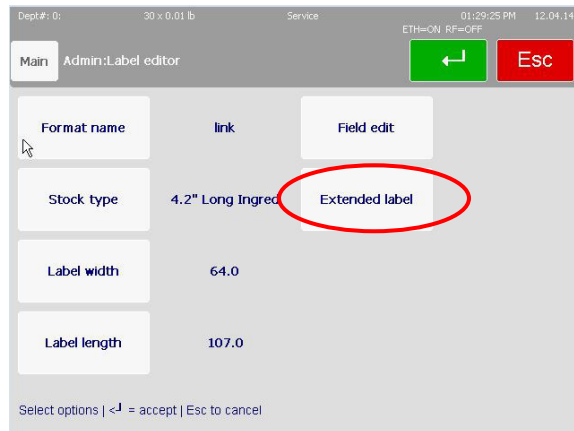

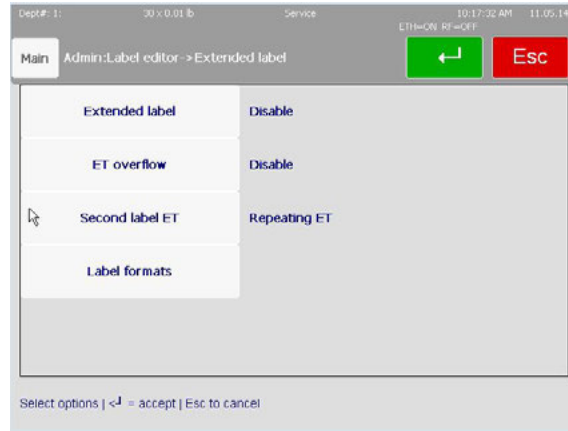

**Extended Label:** Set to disable if the label is not a linked label format. Disable is the default. Set to enable if the label format is a linked label format.

**ET overflow:** if disabled, will not print overflow ET on an additional label (will cut off). Won't force extended label.

**Second label ET:** Only applies if you have a 2<sup>nd</sup> label. If set to 'Repeating', it starts ET over again on 2<sup>nd</sup> label (goes 1<sup>st</sup> label format, extended, 2<sup>nd</sup> label format, extended). If set to 'Continuing', it continues the ET on the 2<sup>nd</sup> label where it left off on the 1<sup>st</sup> label.

**Label Formats:** Define 1<sup>st</sup>, 2<sup>nd</sup>, and extended label formats.

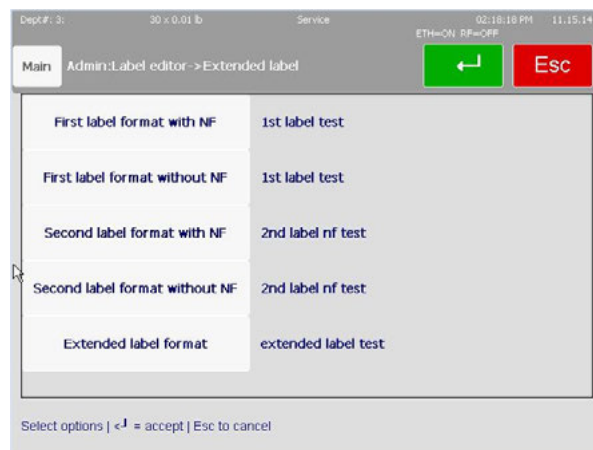

If 'Extended Label' is enabled, the label formats setting is used to link label formats to one 'parent' label format which is assigned in the PLU record.

**First label format:** the label format that will be used on the 1<sup>st</sup> label. Users have the option to choose a different label format for PLUs that have a nutrifact record vs. those that don't.

**Second label format:** the label format that will be used on the 2<sup>nd</sup> label. Users have the option to choose a different label format for PLUs that have a nutrifact record vs. those that don't.

**Extended label format:** the label format that will be used when extra text overflows.

## Tare Preset Configuration

Supervisors will have access to the Tare Preset Configuration option, if 'Enable tare preset config access' is enabled in the Supervisor Permissions settings. Tare Preset Configuration allows supervisors (if enabled) to configure up to five preset tare values. The tare preset configuration editor lists the preset tare descriptions and values. The default list will be empty.

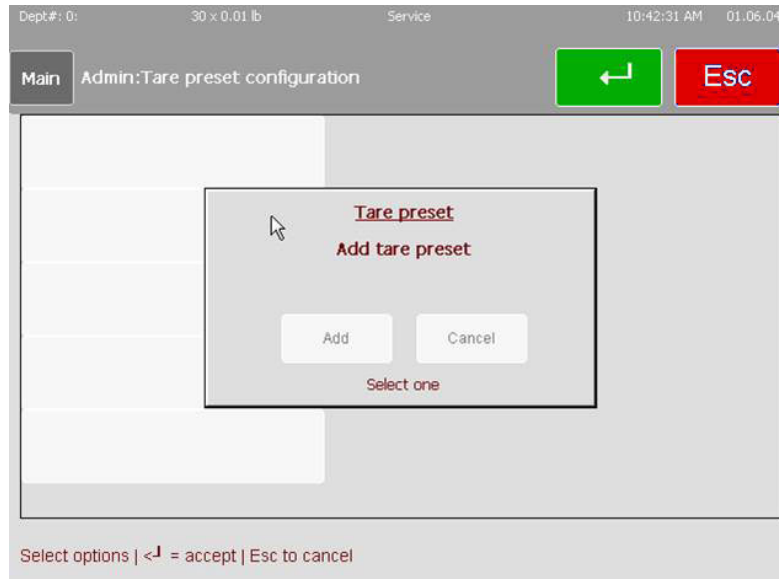

To add a preset tare, select any of the unused tare preset fields and a pop up with "add" and 'cancel' option will guide you through the rest of the process.

Choosing 'add' opens the text editor to enter the description for the preset tare. The tare preset description is alpha number with two lines and 15 characters per line. Once a description is saved, a numeric keypad opens for entering the tare value for the preset. The range for the tare value is based on the scale's load cell calibration (x.xx or x.xxx). If no text is added for description, then the tare value is displayed as the description.



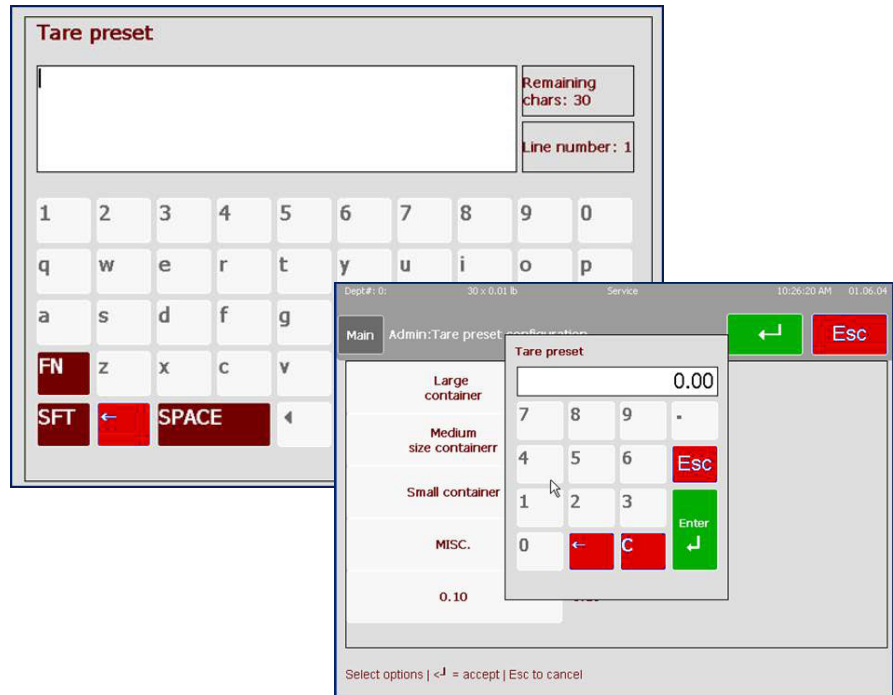

Below is a sample tare preset list:



A configured tare preset can be edited or deleted by selecting the preset:

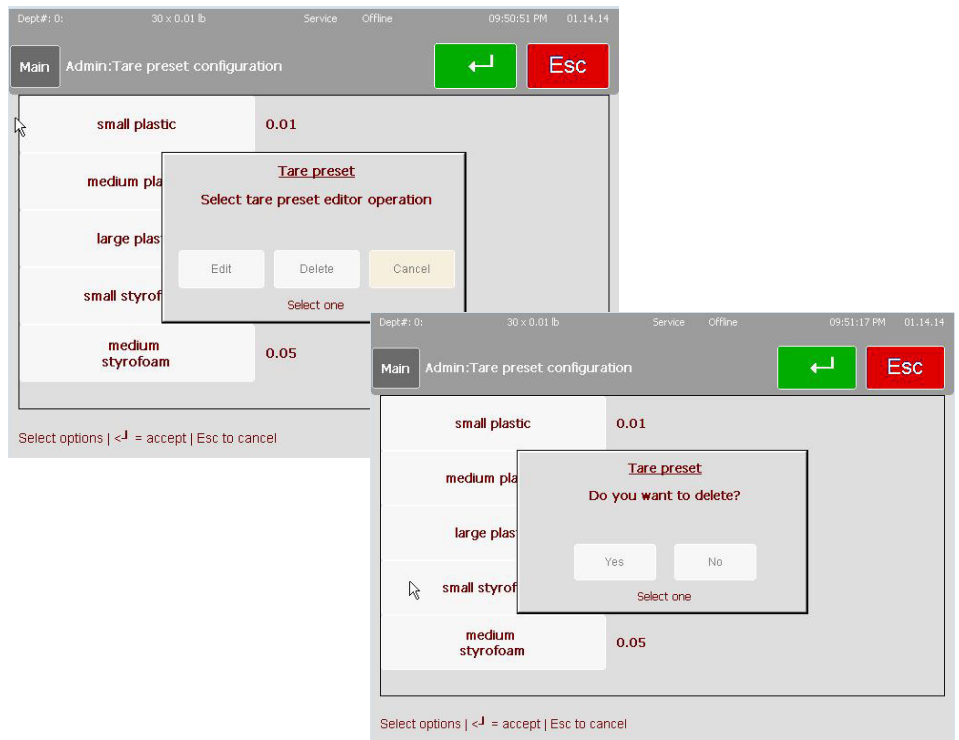

'Edit' opens up the text editor with the current description. 'Delete' deletes the chosen tare preset.

If 'Tare Preset' is enabled in Operator Permissions, Operators who have security to edit tare during a transaction will have the ability to select one of the preconfigured tare values from the tare preset list.

Below is an example of a tare preset list in a transaction screen:

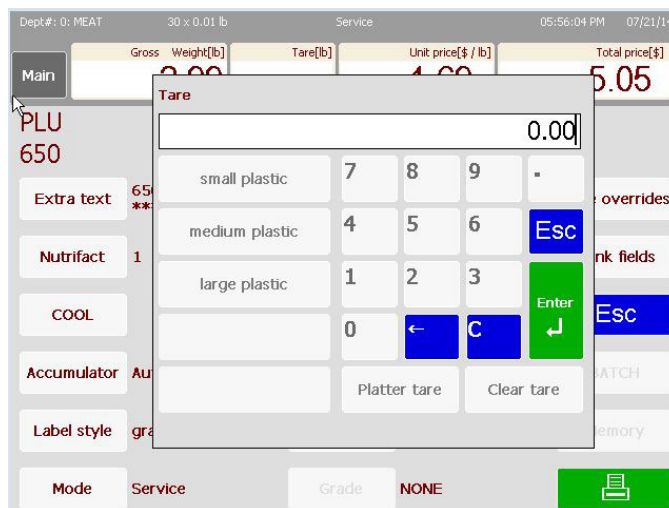

# 4

## Labels

### Loading Labels

When changing a label roll, always look for any label glue or dust buildup and clean if needed. See Chapter 5 for details.

Open the printer door and using the green tab, pull the printer from the housing. Unlock and raise the printhead by pulling up on the latch.

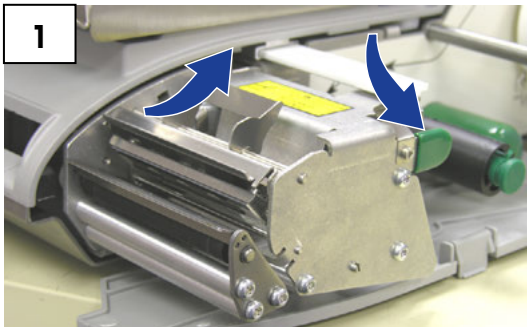

Install the label roll on the supply spool and slide the labels underneath the printer and on top of the platen roller and out the front.



For stripped label mode, remove about 6 inches of labels from the liner. For un-stripped mode, close the printhead.

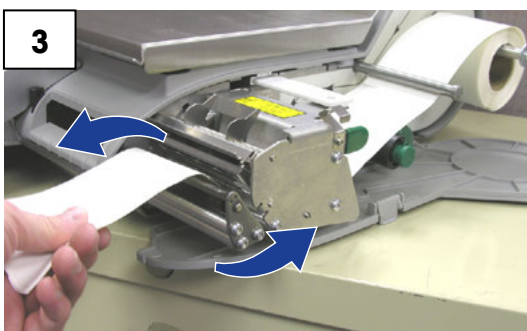

Push in on the green knob to lock the liner into place, and then turn the roller clockwise to take up the slack in the liner. To unlock the liner, pull out gently on the knob. NOTE: The green knob does not come all the way out! Do not use excessive force to pull out on the green knob.



Press down on the printhead latch until it locks down. Push the printer back in and close the door.

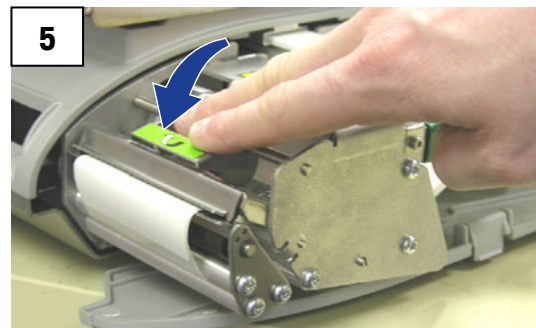

### 6

#### Label Calibration

When first loading labels or changing label sizes, follow this sequence to open the label selection screen:

#### Admin, Labels, Label Group

Select the label size installed in the printer.

#### Printer Setup

Select the label size and make any print adjustments on this screen.

## Label Requirements

The purpose of this section is to specify the requirements of thermal labels to be used in Mettler Toledo retail scale and pre-pack thermal printers.

This document includes dimensional requirements for labels and label rolls, as well as general requirements for label paper, thermal coatings, preprinting inks and adhesives. Use of label materials and designs which meet with these requirements is necessary to ensure operation of the printers in compliance with their respective functional specifications and satisfactory performance of the label in the end-use environment. Labels which do not comply with all of the requirements of this document may function with limitations, but would need to be tested by the customer to insure adequate performance in their application. Customer specified (COD) software is not covered under this specification.

---

## Label Paper

DESCRIPTION, PRICE LABEL: Premium white color, black imaging, with protective coating

DESCRIPTION, DAY-GLO LABEL: Red orange fluorescent, black imaging, with protective coating

WEIGHT: 72 ± 7 grams/square meter

THICKNESS: 82 ± 14 µ meter (0.0032 inch)

### Activation Temperature

STANDARD: Initial 74°C (165°F); Optimum 83°C (181°F)

HIGH SPEED: Initial 66°C (151°F); Optimum 77°C (170°F) – for highest speed printing

HOT BOX: Initial 83°C (181°F); Optimum 91°C (195°F) - for use on food items which are kept warm

SURFACE SMOOTHNESS: The surface of the finished coated paper must be smooth to prevent premature printhead failure. Smoothness must be 40 Sheffield units or smoother.

ION CONTENT: Ions such as sodium (Na) and chlorine (Cl) can cause premature failure of the glass overcoat of a thermal printhead. Paper manufactured specifically for thermal printing with low ion content must be used.

STORAGE LIFE: 18 months minimum when stored at less than 85% relative humidity and less than 35°C (95°F).

### Adhesive

Permanent pressure sensitive – Nominal thickness 10 µ meter (0.0004 inch)

Label must adhere to product with a surface temperature of -15° C (5° F) minimum.

Bond strength must remain permanent over a temperature range of 2°C to 35°C (35°F to 95° F).

### **Release Liner**

DESCRIPTION: White semi-bleached supercalendered Kraft paper with silicone release coating

BASIS WEIGHT:  $68 \pm 3$  gram/square meter

THICKNESS:  $67 \pm 7$   $\mu$  METER (0.0026 INCH)

### **Total Thickness (LABEL + ADHESIVE + LINER)**

$159 \pm 17$   $\mu$  METER (0.0056 to 0.0069 inch)

### **Light transmission for Gap Sensor Operation**

(see optical density definition)

Light transmission at a wavelength of 800 to 900 NM through the liner **ONLY** must be at least three times the transmission through the liner and label together. This means that the transmission optical density of the liner must be at least 0.48 less than the that of the liner and label together

Light transmission at 800 to 900 NM wave length through the liner and label together must be at least 2% of incident light. This corresponds to an optical density of 1.7.

---

## **Label Stripping**

Labels must strip from the liner over a temperature range of 2°C (26°F) at 50% RH to 43°C (110°F) at 85% RH.

---

## **Finished Label Roll Requirements**

### **Core and Method of Label Attachment**

The label stock must **not** be permanently attached to the cardboard core. The liner must separate cleanly from the core with 1.0 pound pull tangent to the core as shown in Figure 1. No core material, tape, or adhesive is to remain on the label or liner after separation. Material, especially hot-melt adhesive, remaining on the label can damage the printhead.

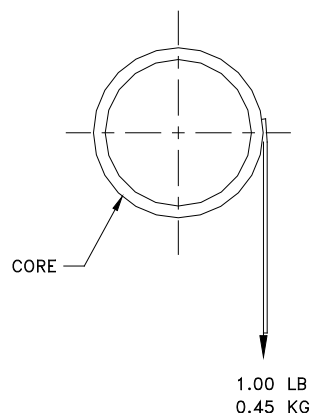

### Die Cutting

Die cutting of the labels must not perforate the release liner.

### Slitting

The release liner must be slit cleanly and be made free of edge slivers and dust by vacuuming or some equally effective process.

### Winding

The labels must be wound face out as shown in Figure 2. The finished roll must be made free of paper dust and loose particles by vacuuming or some equally effective process.

### Label; Curl

Stripped labels must not curl more than 0.020 inch as specified in the figure below.

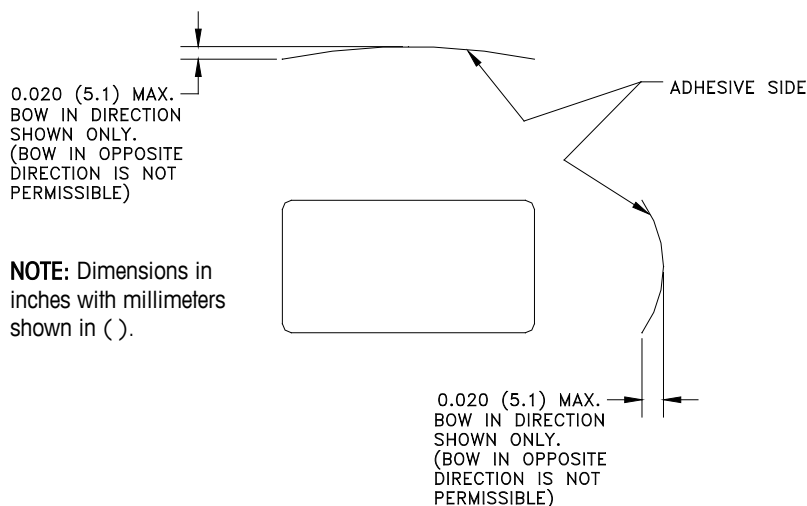
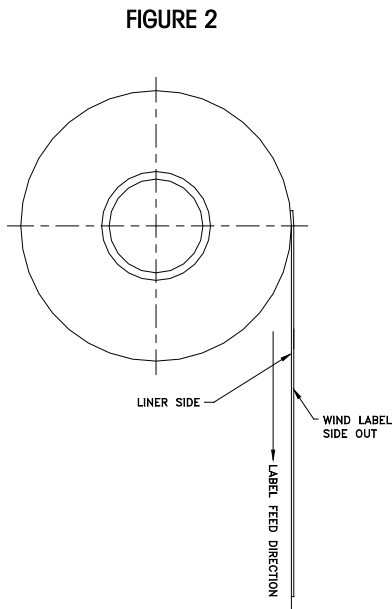

### Splicing

Each roll may contain one splice on non-label side of liner using 0.002 inch maximum thickness tape as shown below.

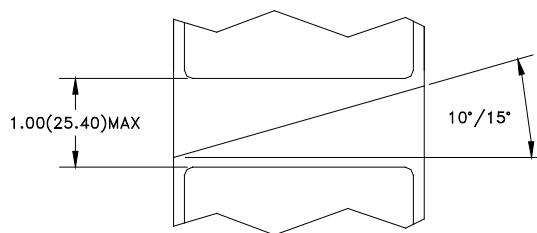

## Finished Label and Roll Dimensional Requirements

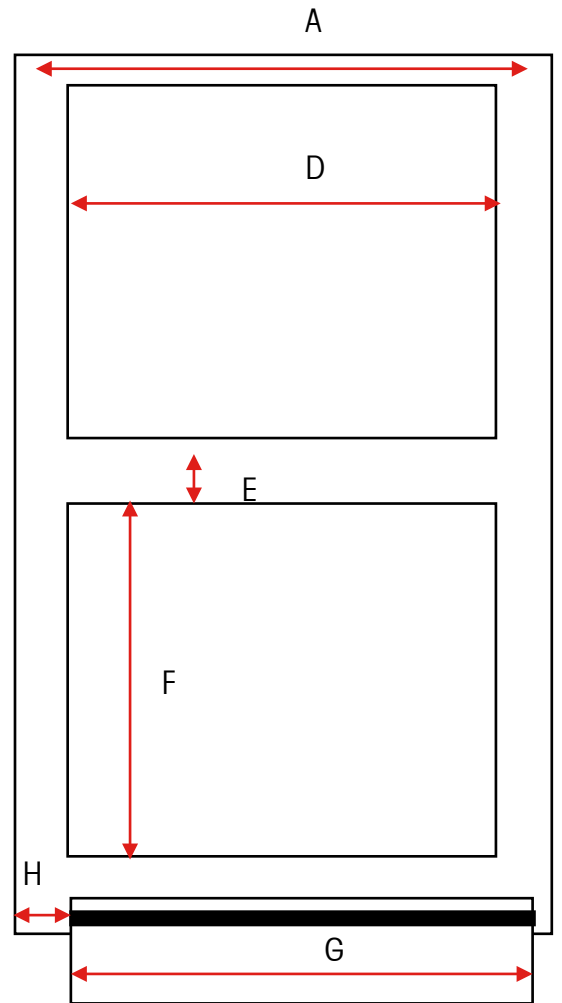
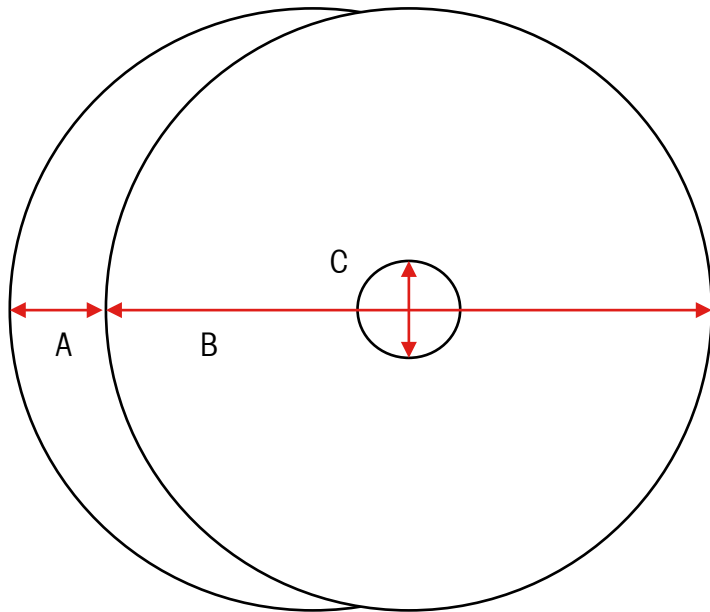

Item	Description	Range	Impact S	
			3"	
			Inches	MM
A	Liner Width	Max	3.346	85
		Min	1.575	40
B	Roll Diameter	Max	6.0	152
C	Core Inside Diameter	Min	1.56	40
D	Label Width	Max	2.635	66.9
		Min	2.615	66.4
E	Gap Width	Min/Max	0.125 +/- .01 inches	
F	Label Length	Max	7.0	177.8
		Min	0.9	23
G	Effective Print Width	Min	2.835	72
H	Left side Offset	Min	0.157	4

### Typical Dimensions – 3" Label Roll

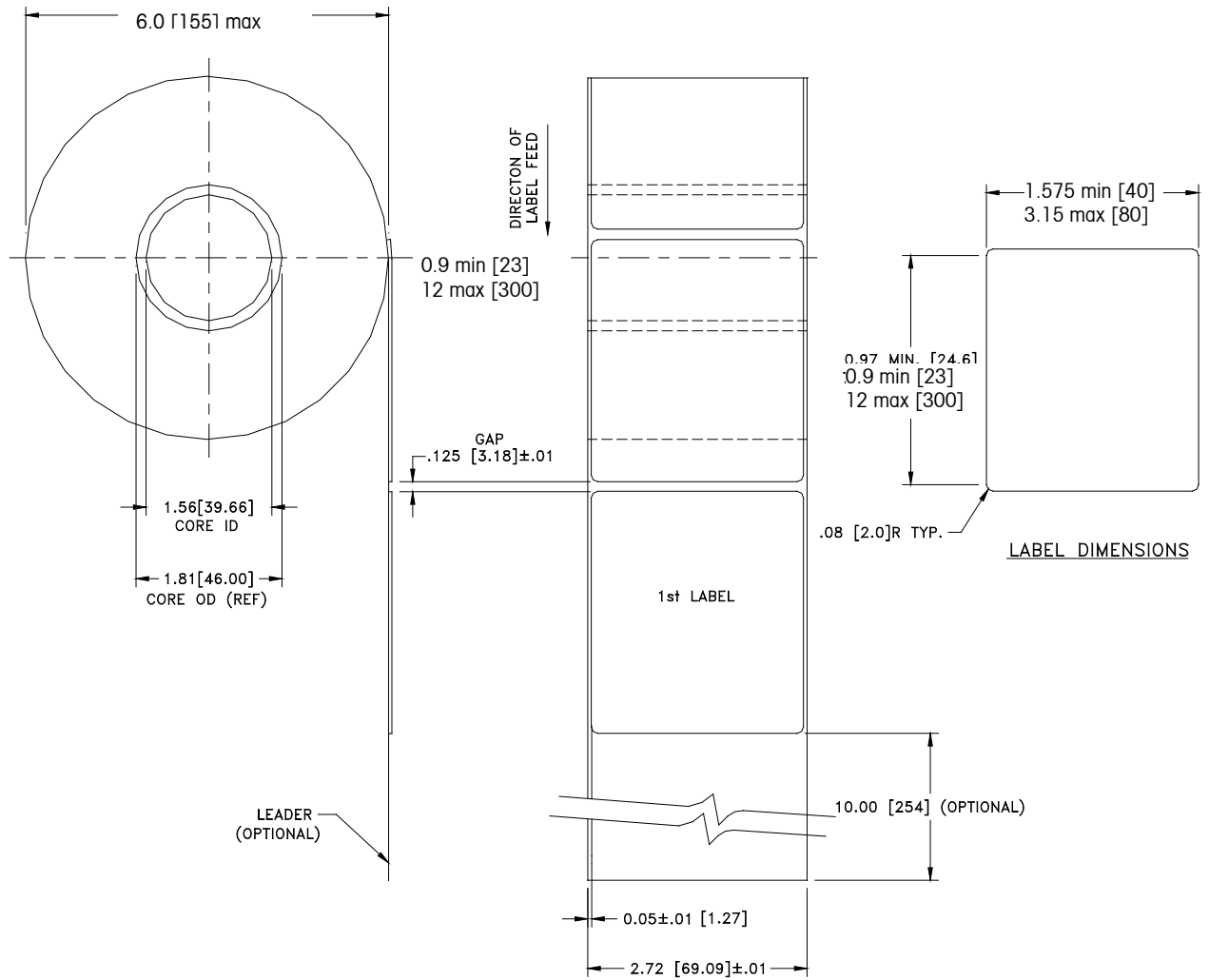

**Note:** Dimensions in inches with millimeters shown in [ ].

FINISHED ROLL AND LABEL DETAIL – PRICE LABEL



## Preprinted Labels

To ensure trouble free operation of the printer gap sensor, and to achieve normal print head life, no pre printing should be placed on the label in the gap sensor path or in areas which will be printed by the scale printer. See Figure 7. However, since preprinting is commonly used by many customers the following guidelines must be followed.

1. Inks used for preprinting must be specially formulated for use in thermal printers. If proper inks are not used they can adhere to the print head. This ink build up on the print head will interfere with heat transfer from the print head to the paper and cause printing elements to burn out. Another problem with inks not formulated for thermal printing is that they can contain chemicals which will cause the glass overcoat to chip off of the print head, causing failure to print in the chipped areas.
2. If black ink is used in preprinting in the gap sensor path shown in Figure 7, a dense black stripe will have to be printed on the back of the liner, as shown in Figure 8, to prevent the gap sensor from being affected by the black preprinting. (Colors other than black might also be a problem and should be tested by the customer) The black stripe must have gaps which correspond to the label gaps. The black stripe on the liner must have a minimum transmission optical density of 2.3 and must be uniform. (see optical density – page 8) In addition, the gap sensor circuit will need to be adjusted for operation with the black stripe as explained in the product service manual. This adjustment will need to be checked any time label paper is changed, for example when labels are procured from a new supplier.
3. If an optical density of at least 2.3 cannot be achieved in the black stripe on the back of the liner, the liner width should be increased (as shown in Figure 9) so that the preprinted label is not in the gap sensor path. For the Impact S, the sensor path in the center of the label must be free of black preprinting.

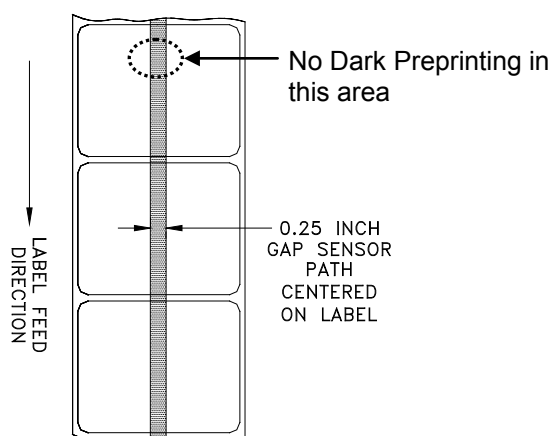
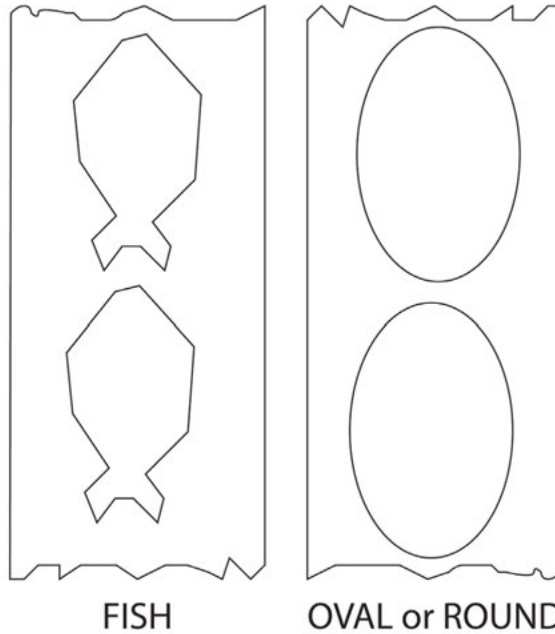

**FIGURE 9**

## Special Shaped Labels

Labels with shapes other than rectangular will cause gap detection errors if the gap dimension (in the gap sensor path) is outside the limits given in this document, or if the edge of the label shape crosses into and out of the sensor path as shown below. For these cases the black stripe will have to be printed on the back of the liner as shown previously. Tests will be needed to determine if the stripe will be adequate or if additional liner width will be required. The safe approach is to use the black stripe configuration shown previously on all odd shaped labels.

Some examples of oddly-shaped labels that will require the black stripe for optical measure.



## Optical Densities

### Definition of Transmission of Optical Density

Transmission optical density is defined as:

Optical Density =  $\log_{10}$  (incident light / transmitted light) =  $\log_{10}$  (100 / % light transmission)

Transmission optical density can be measured with a transmission densitometer that meets ANSI standards. Examples are the Macbeth model TD903 and TD932.

Optical density for 100% light transmission =  $\log_{10}$  (100/100) =  $\log_{10}$  (1) = 0

Optical density for 0.1 % light transmission =  $\log_{10}$  (100/0.1) =  $\log_{10}$  (1000) = 3

### Label and Liner Optical Density

If liner paper transmits 2% of the light which is incident on it, the optical density is  $\log_{10}$  (100/2) = 1.7

If the light transmitted through the liner is 3 times the light transmitted through the liner and label, the relative optical densities are:

$$\begin{aligned} \text{Optical Density of Liner + Label} &= \log_{10} (100 / X) \\ \text{Optical Density of Liner Only} &= \log_{10} (100 / 3X) \\ &= \log_{10} (0.3333X) \\ &= \log_{10} 0.3333 + \log_{10} (X) \\ &= \log_{10}(X) - 0.48 \end{aligned}$$

Therefore, if the liner must transmit 3 times the light that the liner and label transmits, the transmission optical density of the liner must be 0.48 less than the transmission optical density of the liner and label.

## Black Stripe Optical Density

If only 0.5 % of incident light is transmitted through the black stripe, the optical density is:

$$\log_{10} (100 / 0.5) = \log_{10} (200) = 2.3$$

The purpose of specifying a transmission optical density of at least 2.3 for the printed black stripe on the back of the label is to minimize any variation in light transmission as a result of black pre-printing on the front of the label. This variation due to black preprinting can cause the gap sensor to give gap detection errors.

# **METTLER TOLEDO**

**For your notes**

# 5

## Maintenance

### External Cleaning

Open the printer door by pressing down on the release tab.

- Disconnect Power
- Do not use solvents or commercial cleaners on the unit. They may harm the surfaces or damage the touchscreen.
- Do not spray directly on or at the unit!

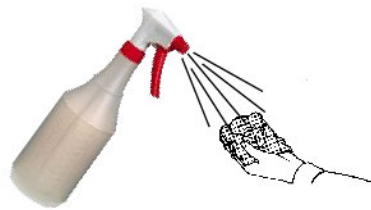

	<b>WARNING</b>
	<b>ELECTRICAL SHOCK HAZARD</b> Disconnect all power to this unit before cleaning or servicing.
<b>NOTICE</b>	
<b>PROPERTY DAMAGE</b> Do not spray or wash down. Disconnect all power to this unit before cleaning. Follow the cleaning instructions detailed in the manual.	

- Touchscreen, keypad, and customer displays - **Only use a soft clean cloth** dampened with mild detergent and water to clean the operator display and customer display screens. Do not scrape with sharp objects.
- Covers and platter – Clean using a soft clean cloth dampened with a mild cleaner or detergent and water.

## Printer Cleaning

Clean the printhead anytime you notice the print quality has degraded.

	<p><b>NOTICE</b></p> <p><b>TO PREVENT EQUIPMENT DAMAGE</b></p> <p>Do not use any metal or sharp object to scrape the printhead or the printer platen roller. This may cause serious equipment damage.</p>
---	---

Lift the latch to release and raise the printhead. Use the **Cleaning Pen** to clean any glue or debris from the black striped area of the printhead. A cotton swab and alcohol may also be used in place of the cleaning pen.

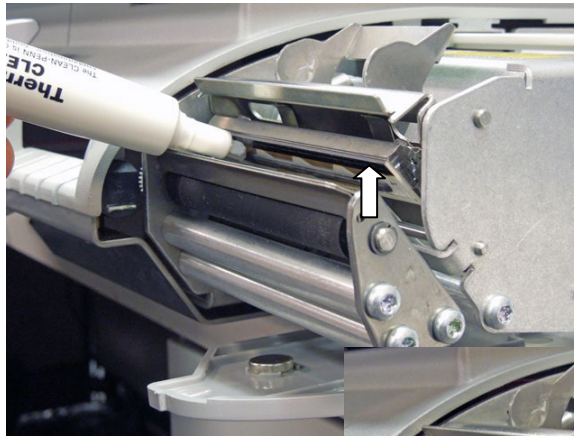

Use a small brush to clean any surfaces with dust or label residue buildup.

Clean the platen roller using a Clean Pen or a swab moistened with alcohol.

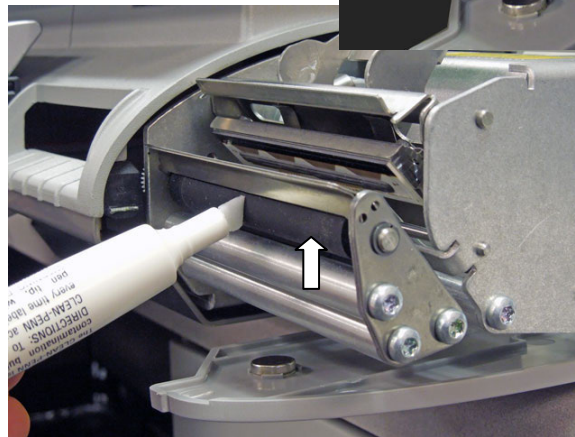
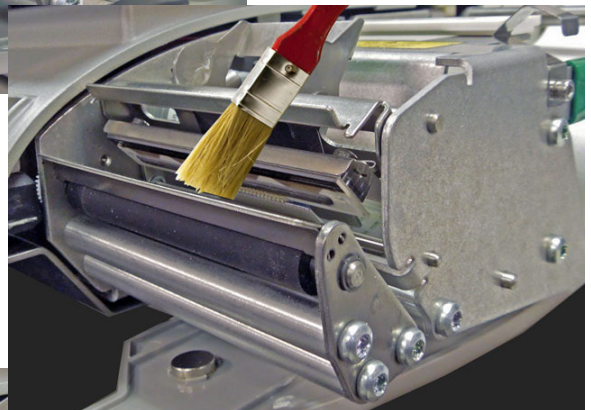

Press the Print button to rotate the roller. Rotate the roller again and repeat the above procedure until the roller is clean.

Note: You may need to thread labels up through the gap sensor to avoid receiving a Low Stock error.

# 6

## Appendix

---

### Geo Index

The Impact scale can compensate for variations caused by gravitational forces. The geo index for the location where the scale is calibrated is programmed into the scale at the factory. When the Impact scale is moved to a new location, the geo index for the new location should be entered in scale setup. Use the following table to determine the geo index for a location.

**METTLER TOLEDO Impact M User's Guide**

Northern and Southern latitude in degrees and minutes	Height above sea level in meters										
	0 325	325 650	650 975	975 1300	1300 1625	1625 1950	1950 2275	2275 2600	2600 2925	2925 3250	3250 3575
	Height above sea level in feet										
	0 1060	1060 2130	2130 3200	3200 4260	4260 5330	5330 6400	6400 7460	7460 8530	8530 9600	9600 10660	10660 11730
0° 0' — 5° 46'	5	4	4	3	3	2	2	1	1	0	0
5° 46' — 9° 52'	5	5	4	4	3	3	2	2	1	1	0
9° 52' — 12° 44'	6	5	5	4	4	3	3	2	2	1	1
12° 44' — 15° 6'	6	6	5	5	4	4	3	3	2	2	1
15° 6' — 17° 10'	7	6	6	5	5	4	4	3	3	2	2
17° 10' — 19° 2'	7	7	6	6	5	5	4	4	3	3	2
19° 2' — 20° 45'	8	7	7	6	6	5	5	4	4	3	3
20° 45' — 22° 22'	8	8	7	7	6	6	5	5	4	4	3
22° 22' — 23° 54'	9	8	8	7	7	6	6	5	5	4	3
23° 54' — 25° 21'	9	9	8	8	7	7	6	6	5	5	4
25° 21' — 26° 45'	10	9	9	8	8	7	7	6	6	5	5
26° 45' — 28° 6'	10	10	9	9	8	8	7	7	6	6	5
28° 6' — 29° 25'	11	10	10	9	9	8	8	7	7	6	6
29° 25' — 30° 41'	11	11	10	10	9	9	8	8	7	7	6
30° 41' — 31° 56'	12	11	11	10	10	9	9	8	8	7	7
31° 56' — 33° 9'	12	12	11	11	10	10	9	9	8	8	7
33° 9' — 34° 21'	13	12	12	11	11	10	10	9	9	8	8
34° 21' — 35° 31'	13	13	12	12	11	11	10	10	9	9	8
35° 31' — 36° 41'	14	13	13	12	12	11	11	10	10	9	9
36° 41' — 37° 50'	14	14	13	13	12	12	11	11	10	10	9
37° 50' — 38° 58'	15	14	14	13	13	12	12	11	11	10	10
38° 58' — 40° 5'	15	15	14	14	13	13	12	12	11	11	10
40° 5' — 41° 12'	16	15	15	14	14	13	13	12	12	11	11
41° 12' — 42° 19'	16	16	15	15	14	14	13	13	12	12	11
42° 19' — 43° 26'	17	16	16	15	15	14	14	13	13	12	12
43° 26' — 44° 32'	17	17	16	16	15	15	14	14	13	13	12
44° 32' — 45° 38'	18	17	17	16	16	15	15	14	14	13	13
45° 38' — 46° 45'	18	18	17	17	16	16	15	15	14	14	13
46° 45' — 47° 51'	19	18	18	17	17	16	16	15	15	14	14
47° 51' — 48° 58'	19	19	18	18	17	17	16	16	15	15	14
48° 58' — 50° 6'	20	19	19	18	18	17	17	16	16	15	15
50° 6' — 51° 13'	20	20	19	19	18	18	17	17	16	16	15
51° 13' — 52° 22'	21	20	20	19	19	18	18	17	17	16	16
52° 22' — 53° 31'	21	21	20	20	19	19	18	18	17	17	16
53° 31' — 54° 41'	22	21	21	20	20	19	19	18	18	17	17
54° 41' — 55° 52'	22	22	21	21	20	20	19	19	18	18	17
55° 52' — 57° 4'	23	22	22	21	21	20	20	19	19	18	18
57° 4' — 58° 17'	23	23	22	22	21	21	20	20	19	19	18
58° 17' — 59° 32'	24	23	23	22	22	21	21	20	20	19	19
59° 32' — 60° 49'	24	24	23	23	22	22	21	21	20	20	19
60° 49' — 62° 9'	25	24	24	23	23	22	22	21	21	20	20
62° 9' — 63° 30'	25	25	24	24	23	23	22	22	21	21	20
63° 30' — 64° 55'	26	25	25	24	24	23	23	22	22	21	21
64° 55' — 66° 24'	26	26	25	25	24	24	23	23	22	22	21
66° 24' — 67° 57'	27	26	26	25	25	24	24	23	23	22	22
67° 57' — 69° 35'	27	27	26	26	25	25	24	24	23	23	22
69° 35' — 71° 21'	28	27	27	26	26	25	25	24	24	23	23
71° 21' — 73° 16'	28	28	27	27	26	26	25	25	24	24	23
73° 16' — 75° 24'	29	28	28	27	27	26	26	25	25	24	24
75° 24' — 77° 52'	29	29	28	28	27	27	26	26	25	25	24
77° 52' — 80° 56'	30	29	29	28	28	27	27	26	26	25	25
80° 56' — 85° 45'	30	30	29	29	28	28	27	27	26	26	25
85° 45' — 90° 00'	31	30	30	29	29	28	28	27	27	26	26



## Country Currency Defaults

Country	Symbol	Total \$ Format	Cent Separator	Cent Separator
Argentina	\$	5.2	,	comma
Belize	BZ\$	5.2	.	period
Bolivia	\$b	5.2	,	comma
Brazil	R\$	5.2	.	period
Canada English	\$	5.2	.	period
Canada French	\$	5.2	,	comma
Caribbean	\$	5.2	.	period
Chile	\$	5.2	,	comma
Colombia	\$	5.2	,	comma
Costa Rica	₡	5.2	,	comma
Dominican Republic	RD\$	5.2	.	period
Ecuador	\$	5.2	,	comma
El Salvador	\$	5.2	.	period
Guatemala	Q	5.2	.	period
Honduras	L.	5.2	.	period
Jamaica	J\$	5.2	.	period
Mexico	\$	5.2	.	period
Nicaragua	C\$	5.2	.	period
Panama	B/.	5.2	.	period
Paraguay	Gs	5.2	,	comma
Peru	S/.	5.2	.	period
Puerto Rico	\$	5.2	.	period
Trinidad & Tobago	TT\$	5.2	.	period
Uruguay	\$U	5.2	,	comma
US Virgin Islands	\$	5.2	.	period
USA	\$	5.2	.	period
Venezuela	Bs	5.2	,	comma

## Country Time Defaults

Country	Default Time	Time Format	Default Display Date	Default Print Date
Argentina	24 hr	hh:mm:ss	DD/MM/YY	DD/MM/YYYY
Belize	12 hr	hh:mm:ss	DD/MM/YY	DD/MM/YYYY
Bolivia	12 hr	hh:mm:ss	DD/MM/YY	DD/MM/YYYY
Brazil	12 hr	hh:mm:ss	DD/MM/YY	DD/MM/YYYY
Canada English	24 hr	hh:mm:ss	DD/MM/YY	DD/MM/YYYY
Canada French	24 hr	hh:mm:ss	YY/MM/DD	YYYY/MM/DD
Caribbean	12 hr	hh:mm:ss	MM/DD/YY	MM/DD/YYYY
Chile	24 hr	hh:mm:ss	DD/MM/YY	DD/MM/YYYY
Colombia	12 hr	hh:mm:ss	DD/MM/YY	DD/MM/YYYY
Costa Rica	12 hr	hh:mm:ss	DD/MM/YY	DD/MM/YYYY
Dominican Republic	12 hr	hh:mm:ss	DD/MM/YY	DD/MM/YYYY
Ecuador	24 hr	hh:mm:ss	DD/MM/YY	DD/MM/YYYY
El Salvador	12 hr	hh:mm:ss	DD/MM/YY	DD/MM/YYYY
Guatemala	12 hr	hh:mm:ss	DD/MM/YY	DD/MM/YYYY
Honduras	12 hr	hh:mm:ss	DD/MM/YY	DD/MM/YYYY
Jamaica	12 hr	hh:mm:ss	DD/MM/YY	DD/MM/YYYY
Mexico	12 hr	hh:mm:ss	DD/MM/YY	DD/MM/YYYY
Nicaragua	12 hr	hh:mm:ss	DD/MM/YY	DD/MM/YYYY
Panama	12 hr	hh:mm:ss	DD/MM/YY	DD/MM/YYYY
Paraguay	12 hr	hh:mm:ss	DD/MM/YY	DD/MM/YYYY
Peru	12 hr	hh:mm:ss	DD/MM/YY	DD/MM/YYYY
Puerto Rico	12 hr	hh:mm:ss	DD/MM/YY	DD/MM/YYYY
Trinidad & Tobago	12 hr	hh:mm:ss	DD/MM/YY	DD/MM/YYYY
Uruguay	12 hr	hh:mm:ss	DD/MM/YY	DD/MM/YYYY
US Virgin Islands	12 hr	hh:mm:ss	MM/DD/YY	MM/DD/YYYY
USA	12 hr	hh:mm:ss	MM/DD/YY	MM/DD/YYYY
Venezuela	12 hr	hh:mm:ss	DD/MM/YY	DD/MM/YYYY

## Misc. Country Defaults

Country	Retail Default Wt	Accuracy	Default Lang
Argentina	kg	Single	ESP
Belize	kg	Single	EN
Bolivia	kg	Single	ESP
Canada English	kg	Single	EN
Canada French	kg	multi	FR
Caribbean	kg	Single	EN
Chile	kg	Single	ESP
Colombia	kg	Single	ESP
Costa Rica	kg	Single	ESP
Dominican Republic	lb	Single	ESP
Ecuador	kg	Single	ESP
El Salvador	lb	Single	ESP
Guatemala	lb	Single	ESP
Honduras	lb	Single	ESP
Jamaica	kg	Single	EN
Mexico	kg	Single	ESP
Nicaragua	kg	Single	ESP
Panama	kg	Single	ESP
Paraguay	kg	Single	ESP
Peru	kg	Single	ESP
Puerto Rico	lb	Single	ESP
Trinidad & Tobago	kg	Single	EN
Uruguay	kg	Single	ESP
US Virgin Islands	lb	Single	EN
USA	lb	Single	EN
Venezuela	kg	Single	ESP

# **METTLER TOLEDO**

**For your notes**



**Mettler-Toledo, LLC  
USA**

1900 Polaris Parkway  
Columbus, OH 43240  
Tel. (800) 523-5123  
(614) 438-4511  
Fax (614) 438-4846

**Canada**

2915 Argentia Road, Unit 6  
Mississauga, Ontario L5N 8G6  
Tel. (800) 263-6593  
Fax (614) 438-4846

Subject to technical changes  
©03/2015 Mettler-Toledo, LLC  
Printed in USA  
MTWT 64070241 R09

[www.mt.com/retail](http://www.mt.com/retail)

For more information



64070241